

Transfer Case VG 500

Order-No. 6510 5078 02

Printed In Germany

0404 0,05 ff

	750.5
Installation Survey	002
Illustrations – Sectional Views – Exploded Views	003
Special Tools	004
Circuit Diagram – Transfer Case	010
Removal and Installation of Transfer Case	050
Assembly and Disassembly of Transfer Case	117
Assembly and Disassembly of Input Shafts and Countershaft	119
Removal, Installation and Sealing of Front End Cover	151
Removal and Installation of Rear End Cover	153
Assembly and Disassembly of Speedometer Drive	189

750.5

Designation	Unit- Model	Installed in Vehicles	
		Sales Designation	Model
VG 500	750.500	1017	380.1
		1019	380.1
		1217	381.1
		1413	383.1
	750.501	LA 1313	352.1
		LA 1513	360.1
		1013	380.1
		1213	381.1
	750.503	LA 911 B	353.1
		LA 1113 B ¹⁾	358.1
	750.504	1417	383.1
		1617	385.1
	750.505	LA 1113 B	358.116 117

¹⁾ Not installed in models 358.116, 117

750.5

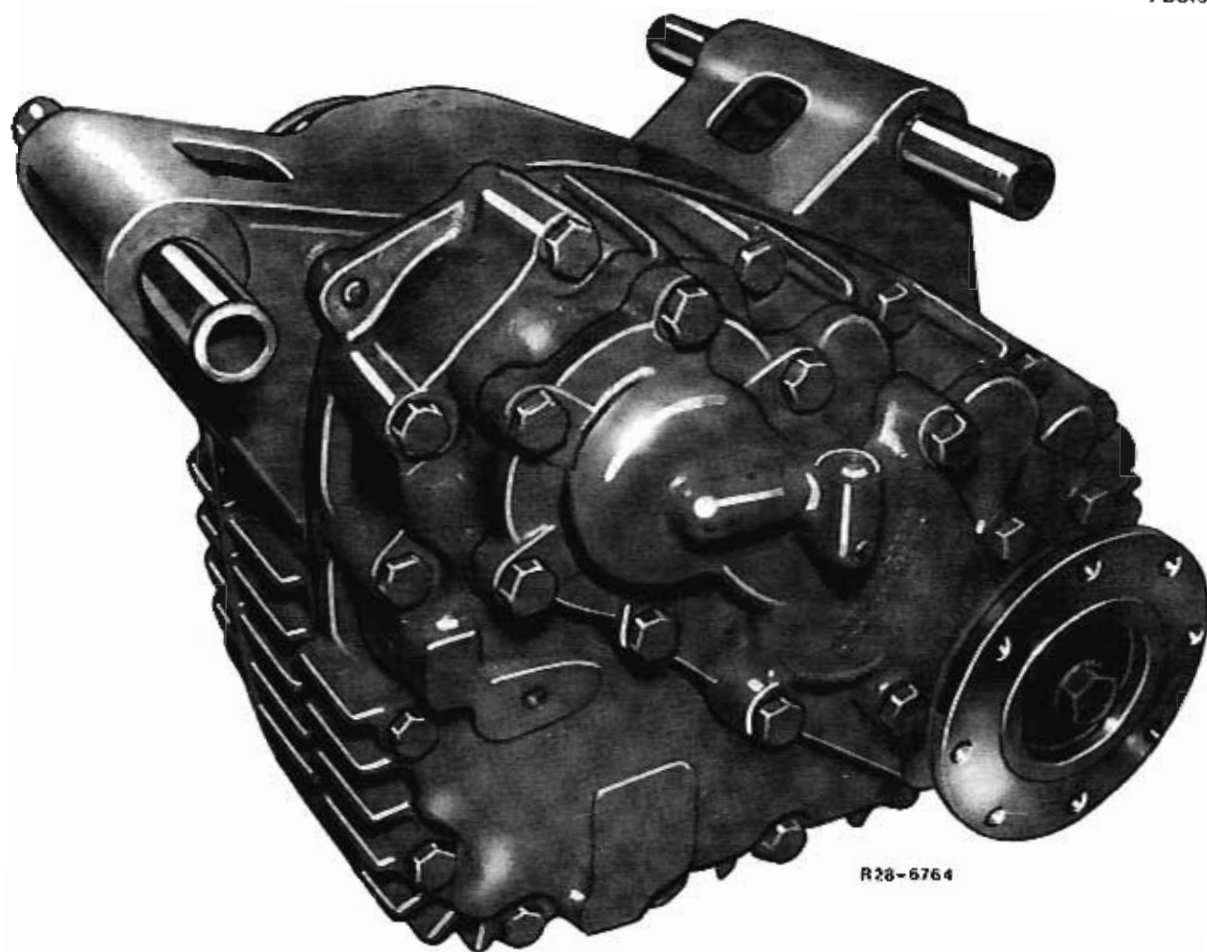

R28-6764

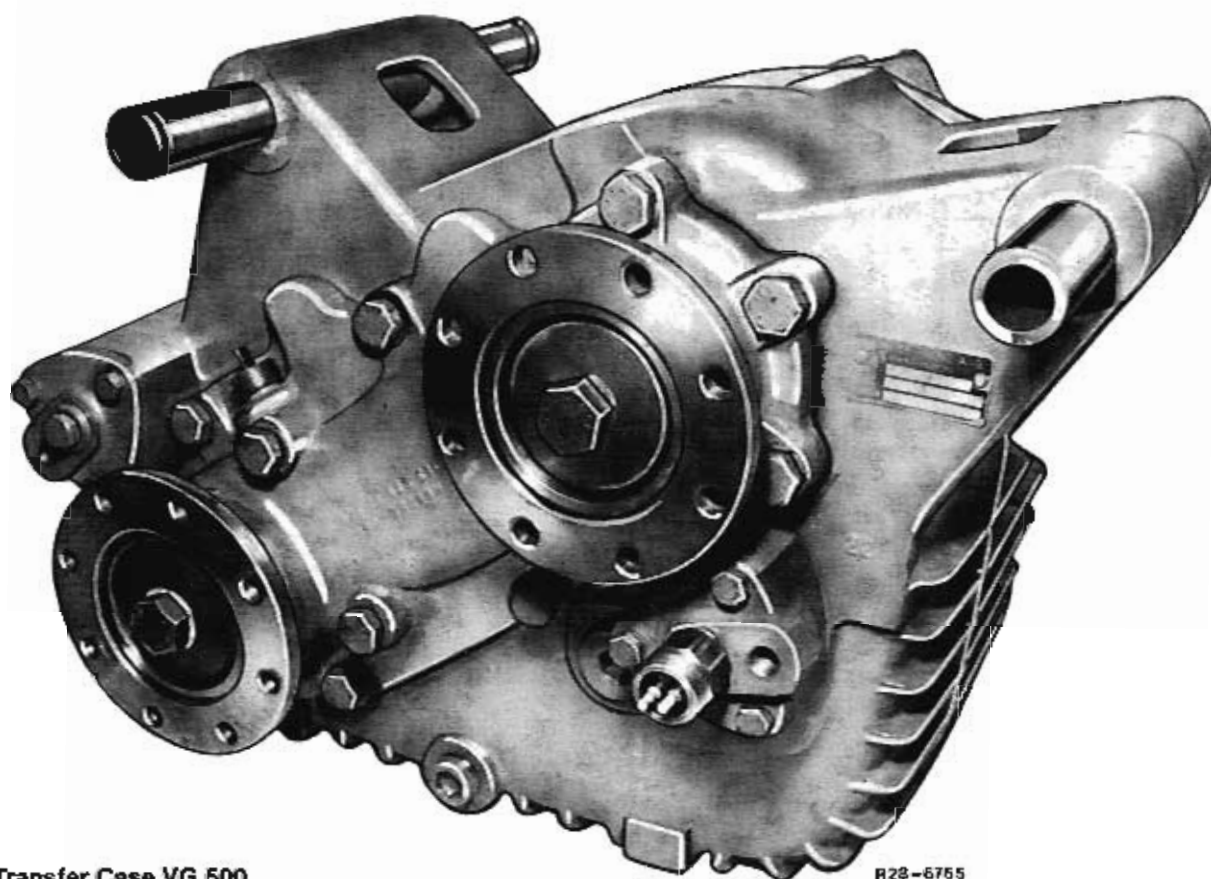

R28-6765

Transfer Case VG 500

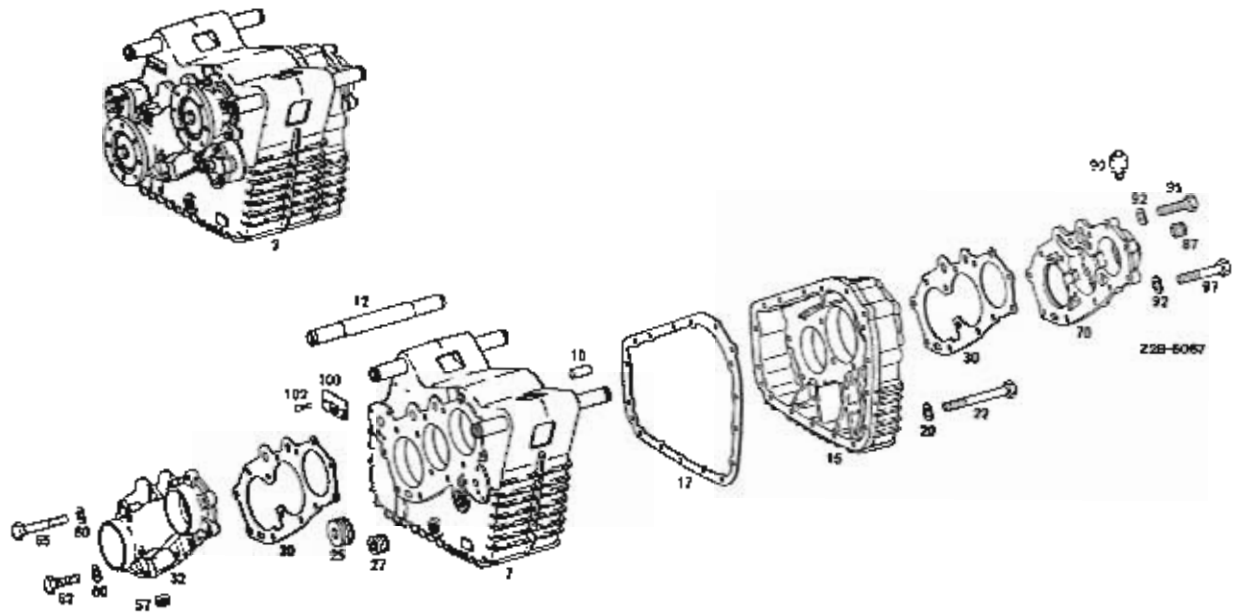

Housing

2	Transfer Case	57	Plug
7	Housing	60	Spring Washer
10	Straight Pin	62	Bolt
12	Pin	65	Bolt
15	Intermediate Flange	70	End Cover
17	Gasket	87	Plug
20	Spring Washer	90	Breather
22	Bolt	92	Spring Washer
25	Screw Plug	95	Bolt
27	Screw Plug	97	Bolt
30	Gasket	100	Unit Identification Plate
32	End Cover	102	Grooved Pin

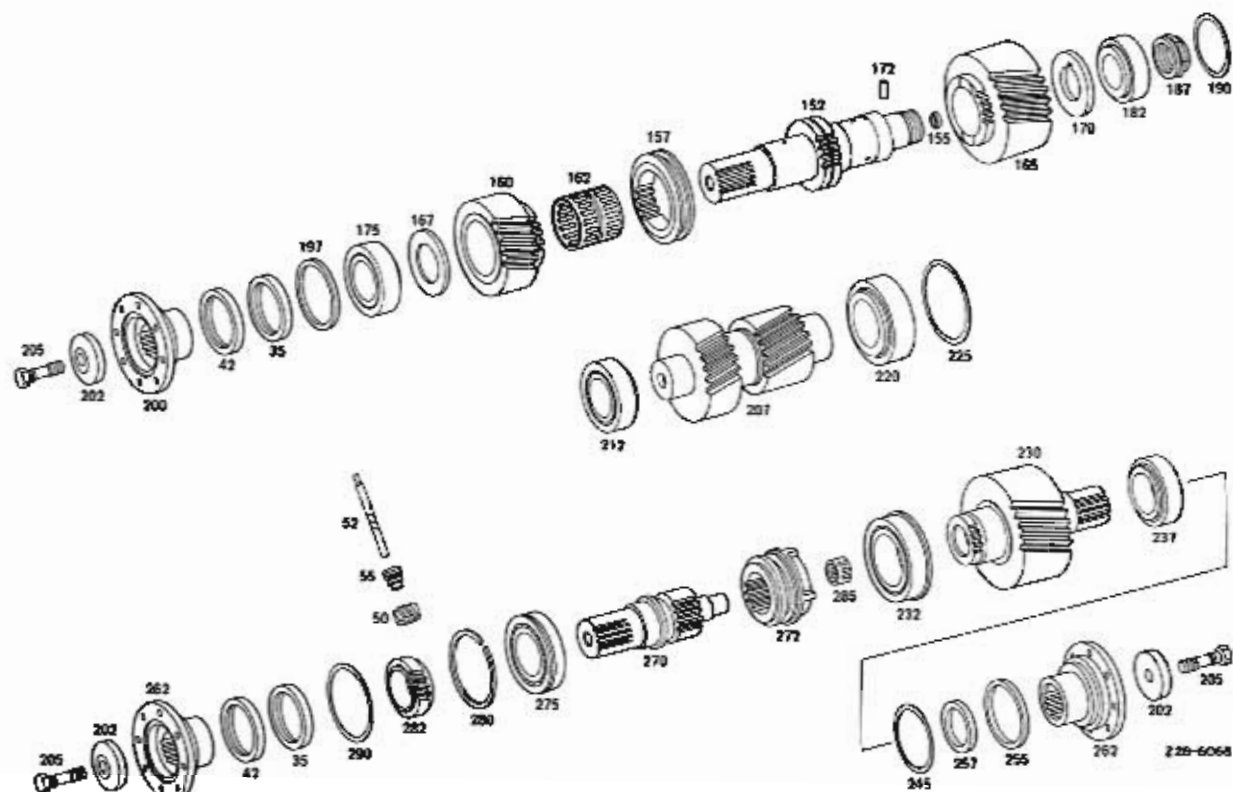

Gears

35	Sealing Ring	202	Thrust Washer
42	Sealing Ring	205	Bolt
50	Drive Gear	207	Shaft
52	Shaft	212	Taper Roller Bearing
55	Threaded Bush	220	Taper Roller Bearing
152	Input Shaft	225	Shim
155	Oil Collector Ring	230	Input Shaft
157	Shift Dog	232	Taper Roller Bearing
160	Gear	237	Taper Roller Bearing
162	Roller Cage Assembly	245	Shim
166	Gear	255	Spacing Ring
167	Thrust Washer	257	Spacing Ring
170	Thrust Washer	262	Coupling Flange
172	Straight Pin	270	Input Shaft
175	Taper Roller Bearing	272	Shift Dog
182	Taper Roller Bearing	275	Deep groove Ball Bearing
187	Nut	280	Snap Ring
190	Shim	282	Drive Gear
197	Spacing Ring	285	Roller Cage Assembly
200	Coupling Flange	290	Shim

28.3 Illustrations – Sectional Views – Exploded Views

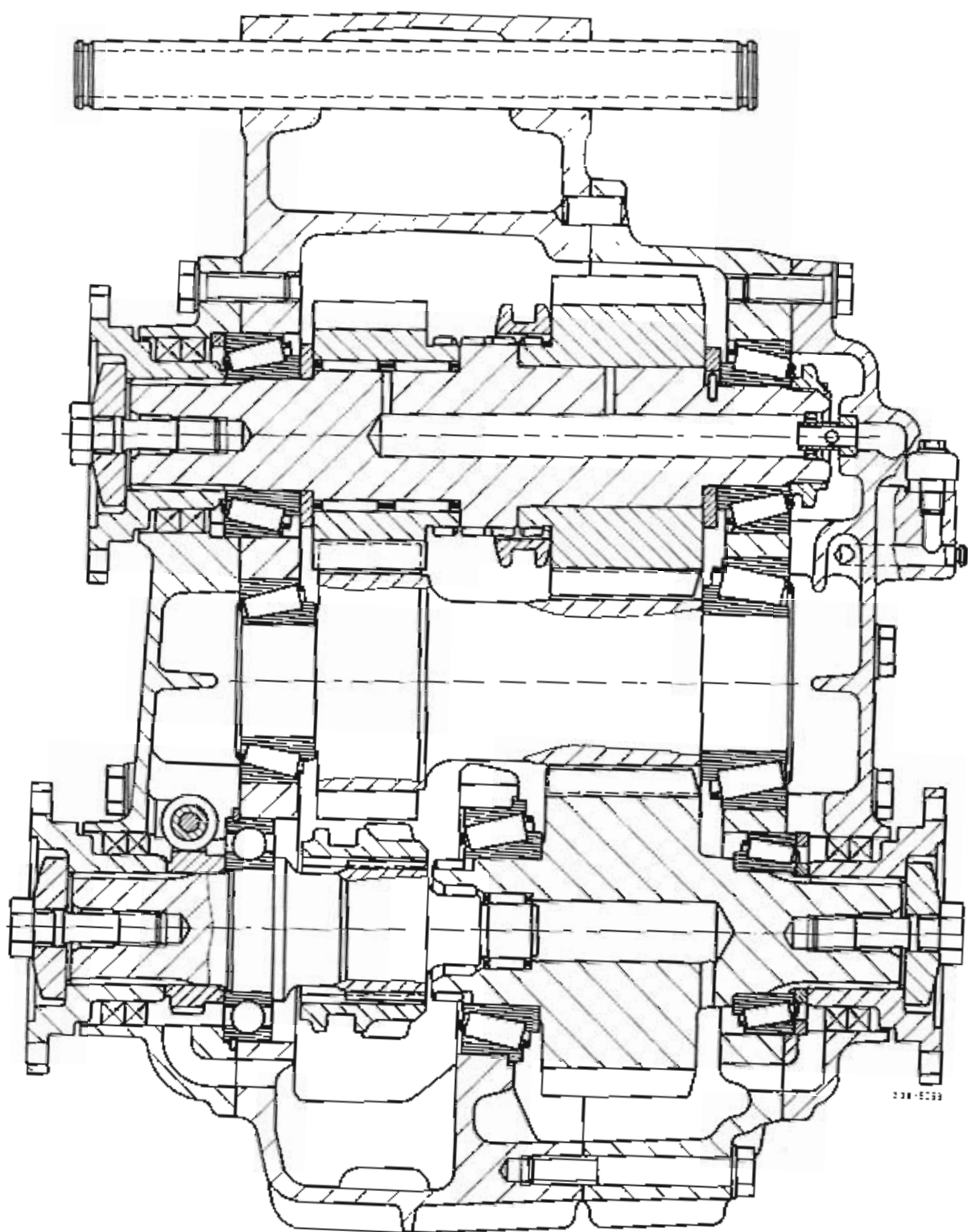

Transfer Case VG 500

Tool	Part Number
Open End Wrench Insert	000 589 21 01 00
	00 589 22 01 00
Drift	312 589 15 15 00
Drift	314 589 03 15 00
Drift	387 589 05 15 00
Torque Wrench	000 589 64 21 00
Torque Wrench Handle	001 589 44 21 00
Dial Gauge	001 589 53 21 00
Retaining Wrench	366 589 00 31 00
Two-Legged Puller	000 589 89 33 00
Puller	001 589 19 33 00
Puller	001 589 40 33 00
Puller	035 589 01 33 00
Dial Gauge Holder	343 589 00 40 00
Clamping Bar	000 589 59 63 00
Thrust Piece	387 589 01 63 00
Torque Wrench	000 589 10 99 01
Clamping Ring	380 589 00 34 00
	380 589 01 34 00
	380 589 02 34 00

28.3 Illustrations – Sectional Views – Exploded Views

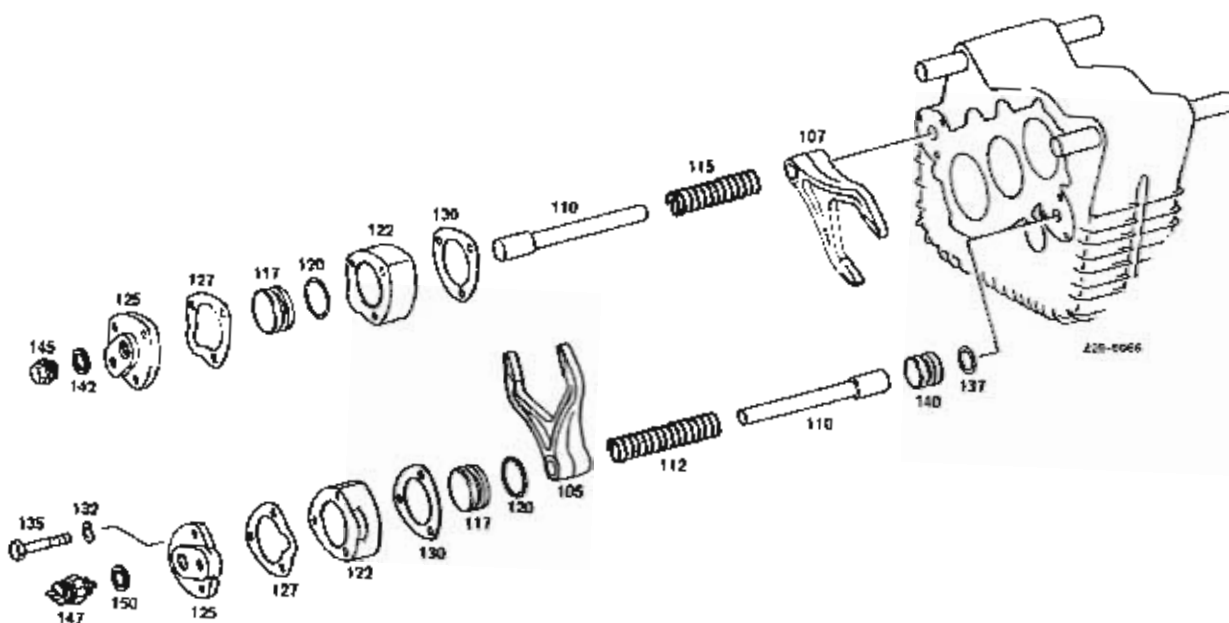

Shift Mechanism

105	Selector Fork	130	Gasket
107	Selector Fork	132	Spring Washer
110	Rod	135	Bolt
112	Spring	137	Sealing Ring
115	Spring	140	Piston
117	Piston	142	Sealing Ring
120	Sealing Ring	145	Screw Plug
122	Shift Cylinder	147	Switch
125	Cover	150	Sealing Ring
127	Gasket		

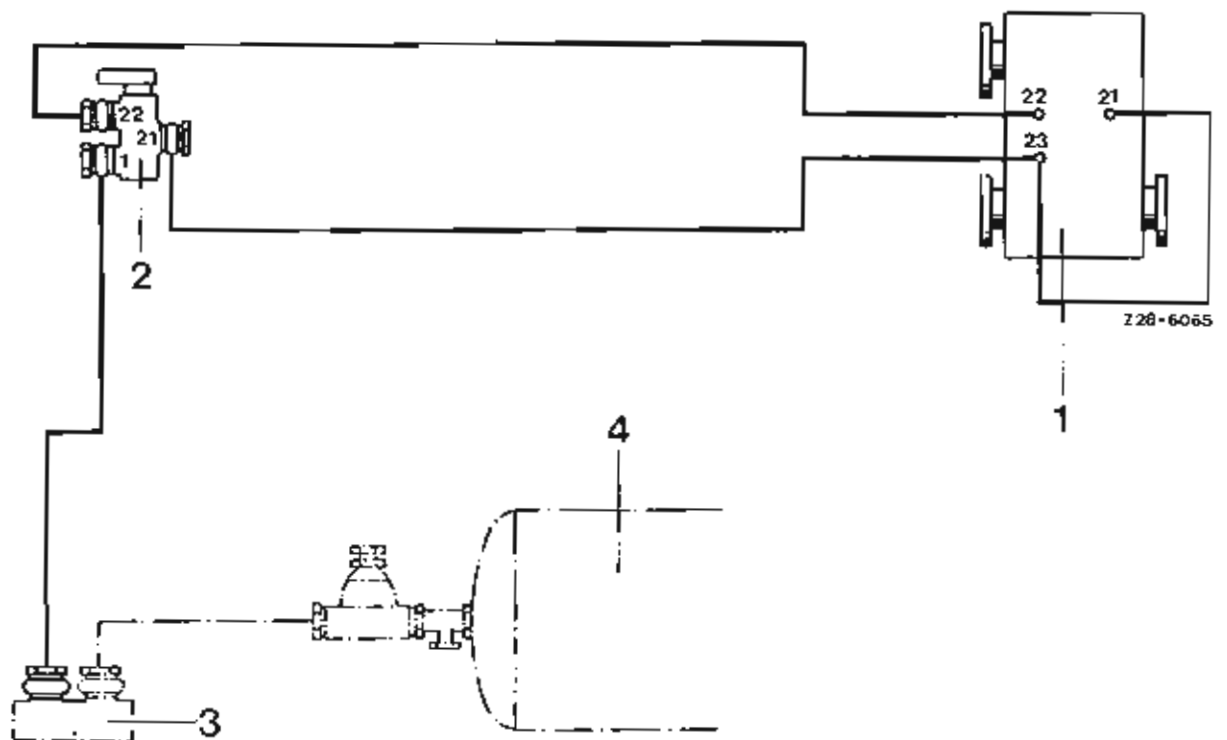

- 1 Transfer Box
- 3 Actuating Valve
- 3 Proportioning Pressure Regulator
- 4 Reservoir



Compressed Air Supply

	air exhausting	air under pressure
On-road	(21) (22) (23)	
Neutral		(21) (22) (23)
Off-road	(22)	(21) (23)

Tightening Torques Nm (kpm)

Propeller shaft retaining nuts (SW 17)	78	(7.6)
Propeller shaft retaining nuts (SW 19)	135	(13.5)

Special Tools

Torque wrench handle		001 589 44 21 00
Open end wrench insert SW 17		000 589 21 01 00
Open end wrench insert SW 19		000 589 22 01 00

Removal

1 Using torque wrench handle and open end wrench, unscrew propeller shaft at flange to manual transmission.

Torque wrench handle 001 589 44 21 00
Open end wrench insert 000 589 21 01 00

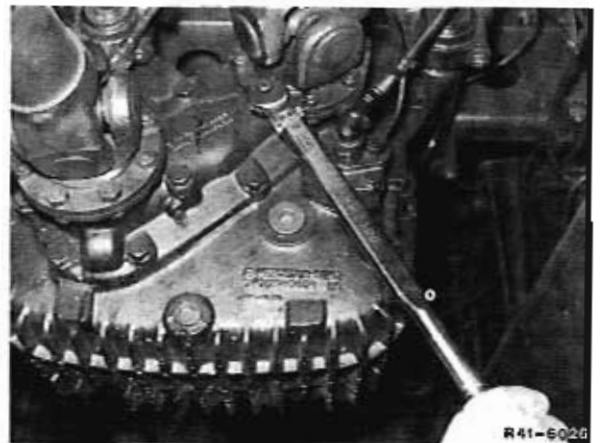

2 Using torque wrench handle and open end wrench, unscrew propeller shaft at flange to front axle.

Torque wrench handle 001 589 44 21 00
Open end wrench insert 000 589 21 01 00

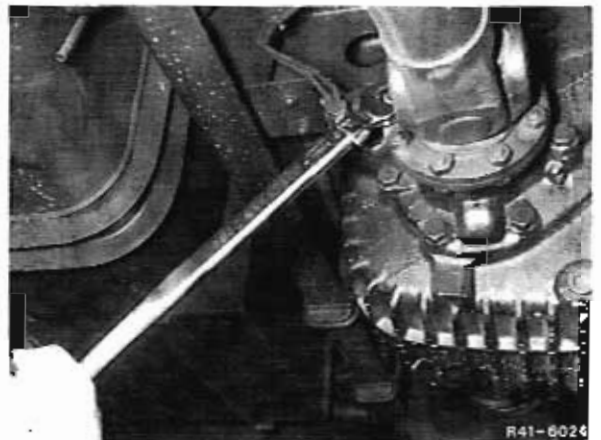



7 Disconnect pneumatic control line at connection 23.

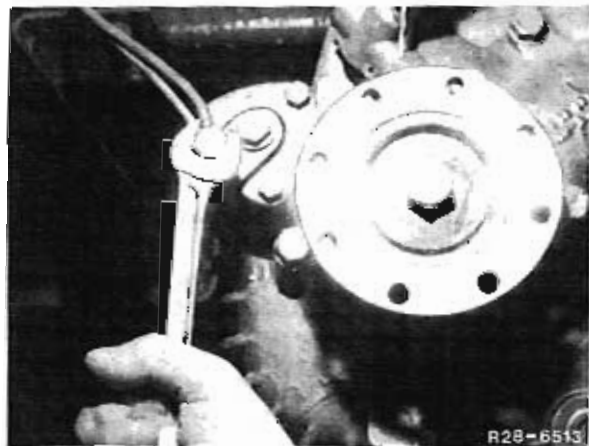

8 Unscrew speedometer shaft at angle drive.

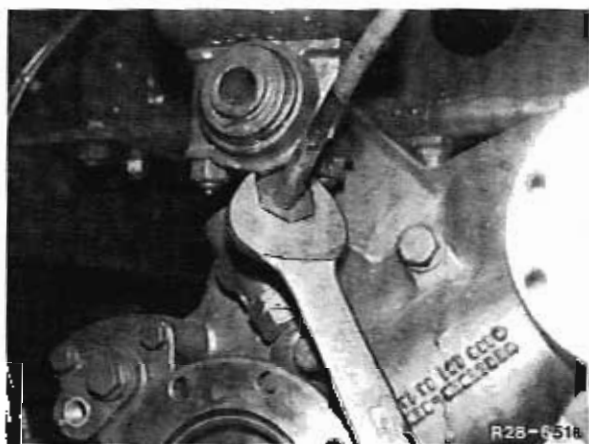

9 Place transmission lifting mechanism beneath transfer case and raise slightly.

10 Release front clamping bolts of transfer case mounting and remove. Remove bearing shells.

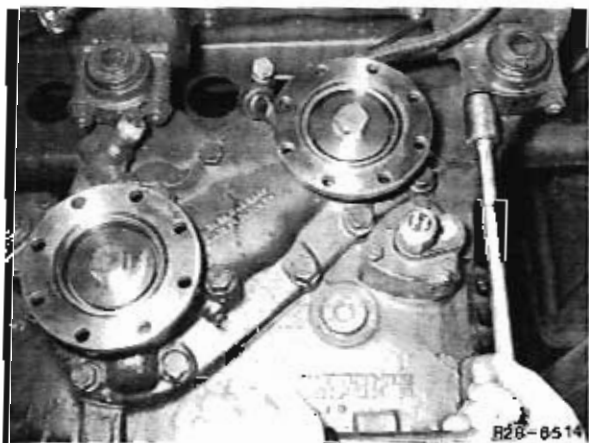

11 Release rear clamping bolts of transfer case mounting and remove. Remove bearing shells.

12 Lower transfer case and remove from beneath vehicle.

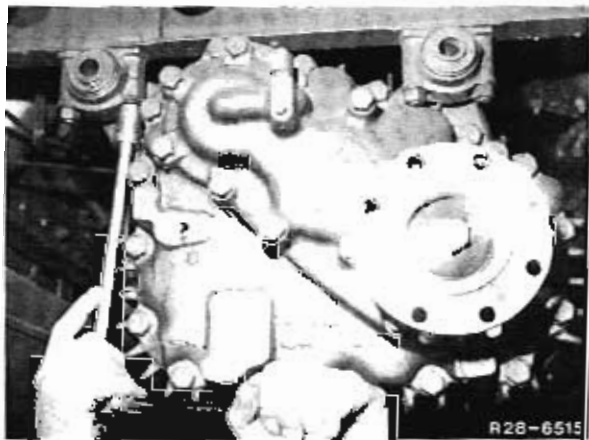



7 Connect pneumatic control line at connection 22.



R28-6512

8 Connect pneumatic control line at connection 21.

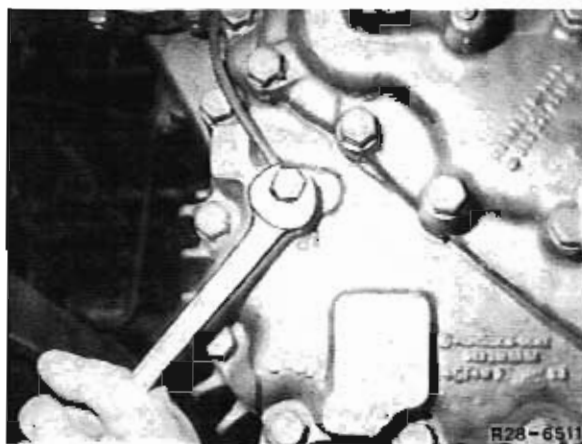

R28-6511

9 Fit electric connection for indicating front wheel drive in position and tighten with cap nut.

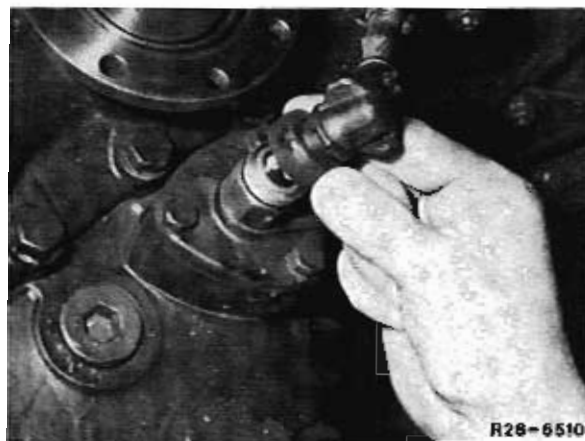

R28-6510

10 Tighten propeller shaft at flange to rear axle using torque wrench handle and open end wrench insert, tighten SW 19 to 135 Nm (13,5 kpm) and SW 17 to 76 Nm (7,6 kpm).

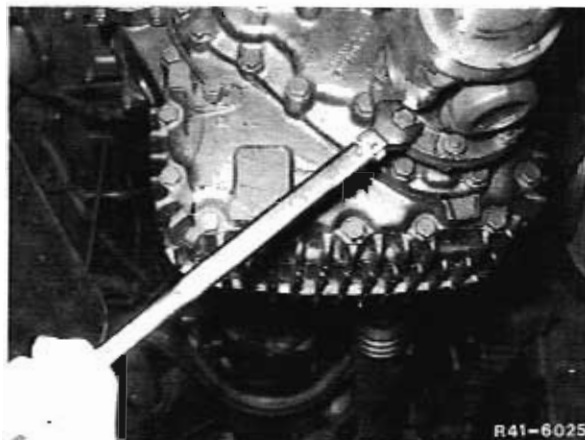

R41-6025

Torque wrench handle 001 589 44 21 00
 Open end wrench insert 000 589 21 01 00
 Open end wrench insert 000 589 22 01 00

28.3 Removal and Installation of Transfer Case

3 Using torque wrench handle and open end wrench insert, unscrew propeller shaft at flange to rear axle.

Torque wrench handle 001 589 44 21 00
Open end wrench insert 000 589 21 01 00
Open end wrench insert 000 589 22 01 00

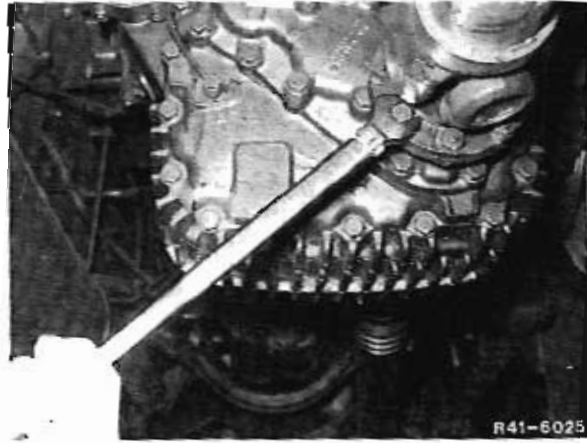

4 Detach electric connection for indicating front wheel drive and pull off.

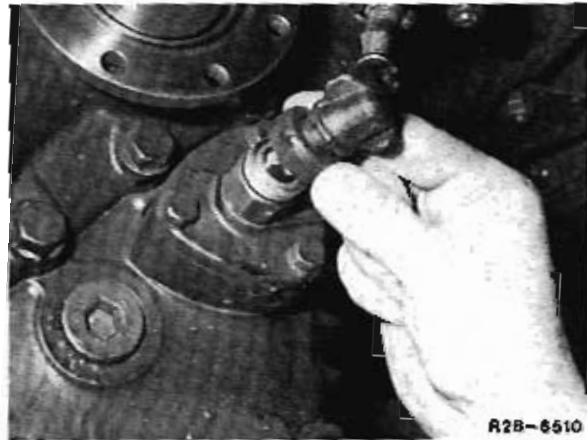

5 Disconnect pneumatic control line at connection 21.

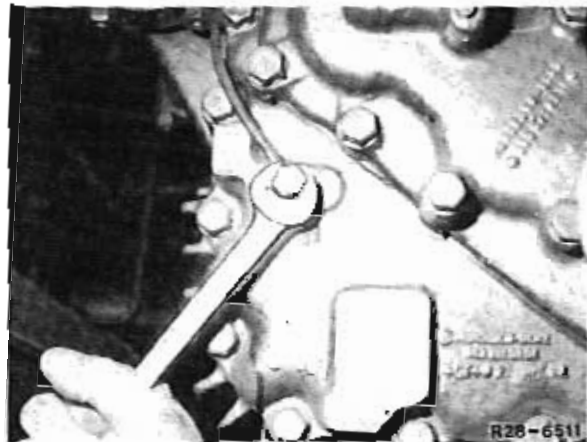

6 Disconnect pneumatic control line at connection 22.

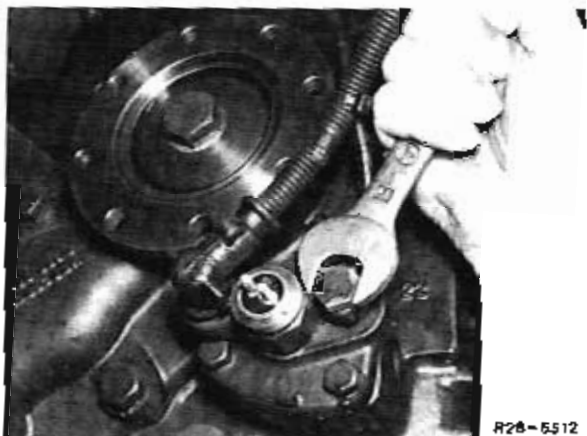





750.5

Tightening Torques Nm (kpm)

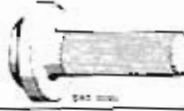
Clamping bolts – Intermediate Housing	90	(9)
Clamping bolts – Shift Cylinder	25	(2.5)

Special Tools

Drift		312 589 15 15 00
Drift		314 589 03 15 00
Dial Gauge		001 589 53 21 00
Dial Gauge Holder		343 589 00 40 00
Clamping Bar		000 589 59 63 00

Technical Data

Axial play input shaft (upper shaft) from transmission	0,08 ± 0,02
Axial play countershaft	0,08 ± 0,02
Axial play input shaft to rear axle	0,08 ± 0,02

Disassembly

- 1 Remove front end cover (28.3-151).
- 2 Remove rear end cover (28.3-153)
- 3 Release and remove clamping bolts along perimeter of intermediate housing.

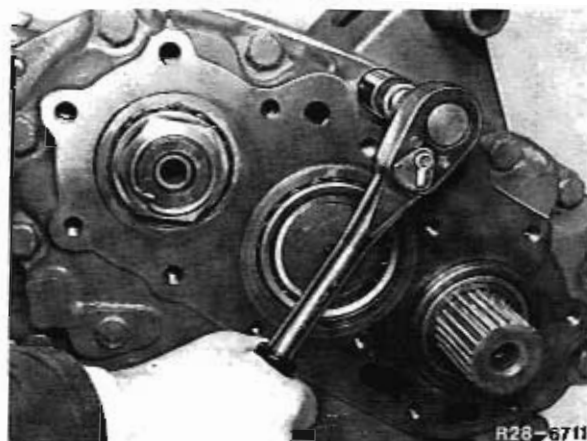

- 4 Detach intermediate housing from main housing.

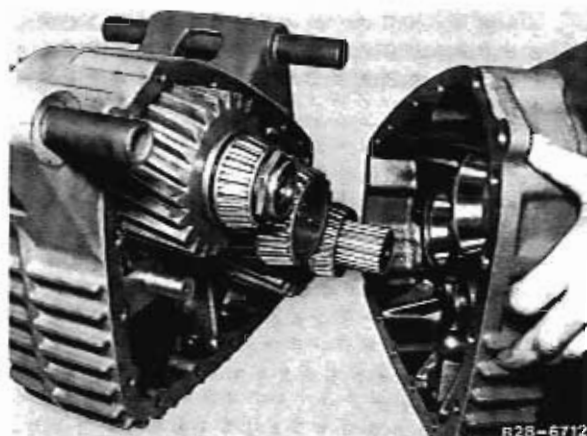

28.3 Removal and Installation of Transfer Case

Installation

1 Place transfer case on transmission lifting mechanism or lever gear and position beneath vehicle preparatory to installation.

2 Raise transfer case until the rubber bearings sit in the upper bearing shells. Insert lower bearing shells and tighten nuts on clamping bolts. Tighten bolts at front transfer box mounting evenly.



3 Tighten bolts at rear transfer box mounting evenly.

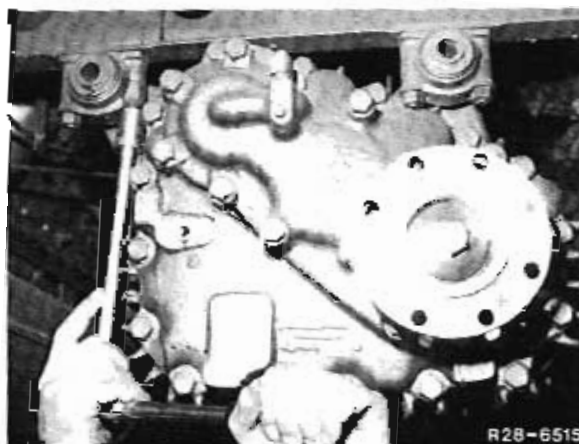

4 Tighten speedometer shaft at angle drive.

5 Seal speedometer shaft with lead seals.



6 Connect pneumatic control line at connection 23.

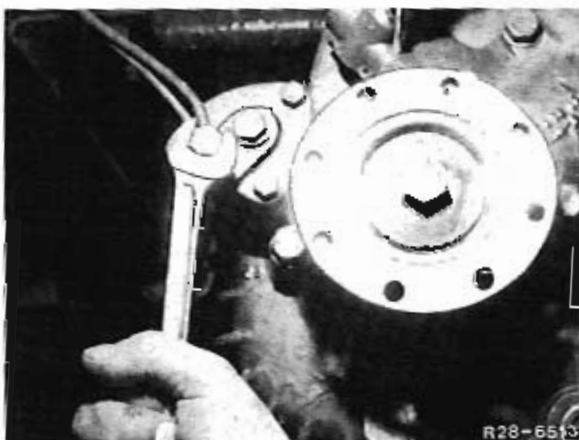

9 Lift countershaft out of the transmission housing (for countershaft disassembly see 28.3-119).

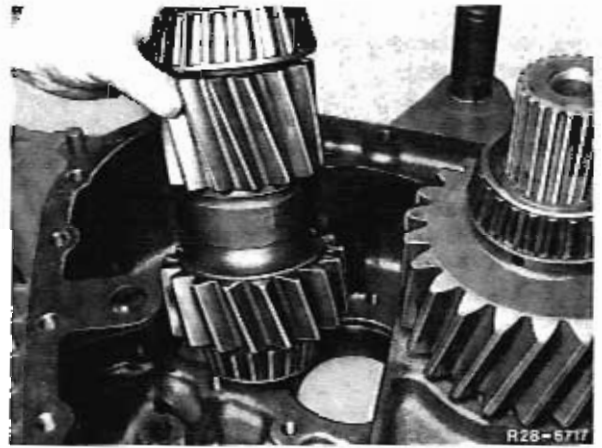

10 Lift input shaft for rear axle out of transmission housing (for input shaft disassembly see 28.3-119).

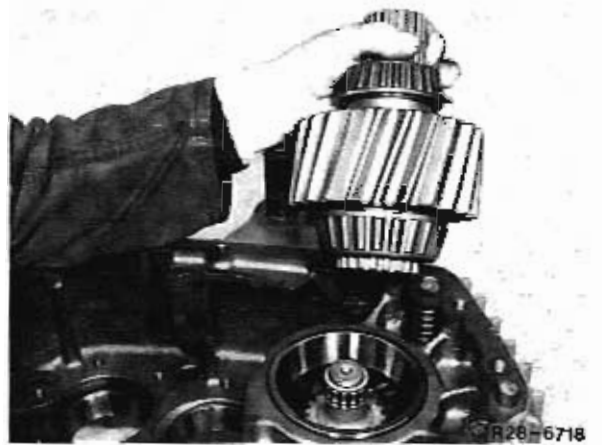

11 Remove roller bearing on input shaft to front axle.



12 Tapping gently, press input shaft for front axle out of transmission housing and selector sleeve (for input shaft disassembly see 28.3-119).

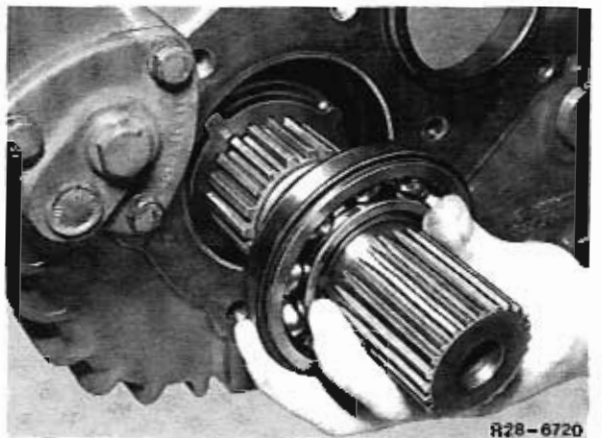

28.3 Removal and Installation of Transfer Case

11 Tighten propeller shaft at flange to front axle to 76 Nm (7.6 kpm) using torque wrench handle and open end wrench insert.

Torque wrench handle 001 589 44 21 00
Open end wrench insert 000 589 21 01 00

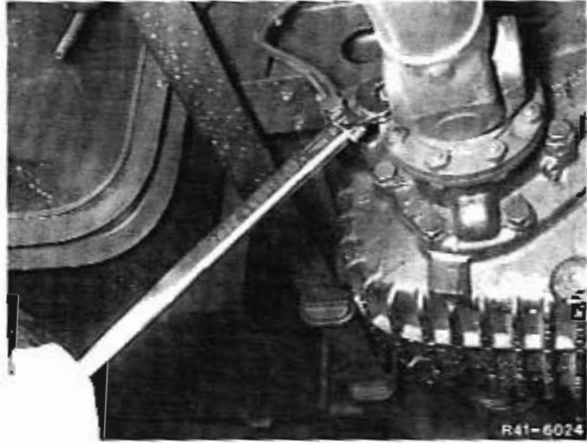

12 Tighten propeller shaft at flange to manual transmission to 76 Nm (7.6 kpm) using torque wrench handle and open end wrench insert.

13 Correct oil level in transfer case.

Torque wrench handle 001 589 44 21 00
Open end wrench insert 000 589 21 01 00

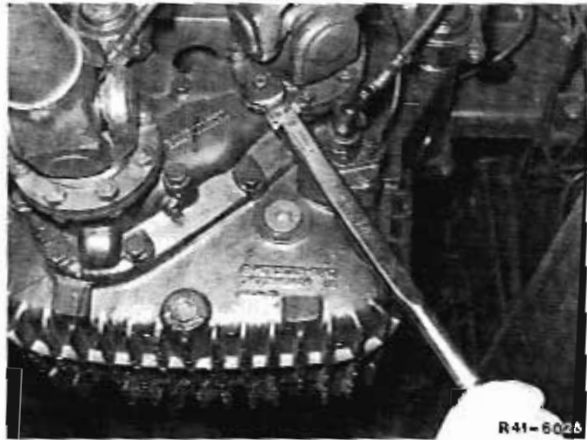

- 17 Using special tool, drive out outer race of taper roller bearing of bearing for input shaft to rear axle.

Drift 312 589 15 15 00

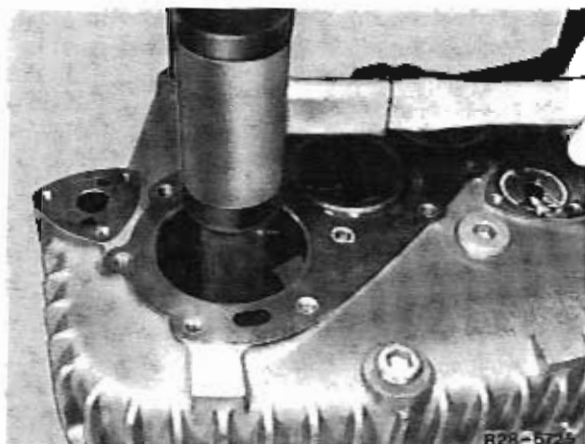

- 18 Using appropriate drift, drive the remaining bearing outer races out of the transmission and intermediate housings.

- 19 Inspect all parts and check for wear.

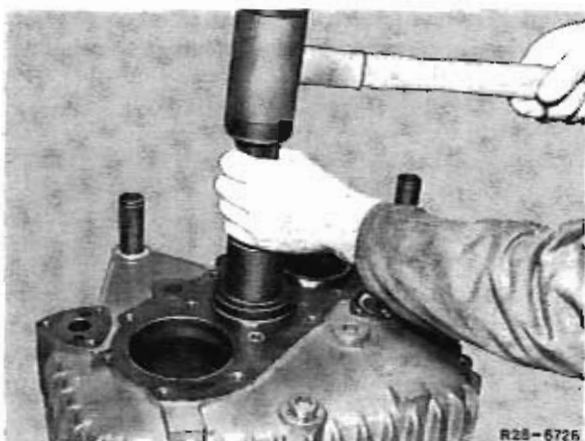

Assembly

- 1 Using special tool, drive large taper roller bearing outer race for input shaft to rear axle as far as collar.

Drift 314 589 03 15 00

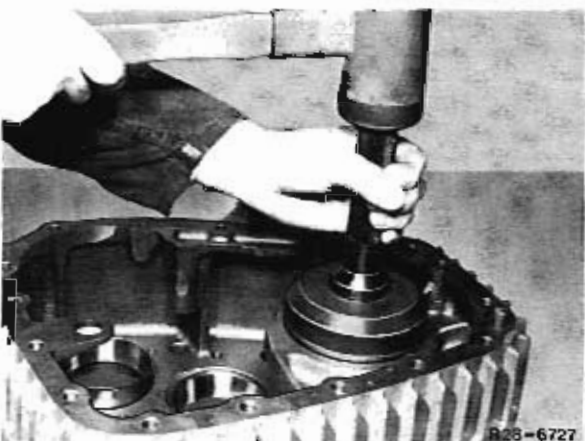

- 2 Using the appropriate drift, insert remaining taper roller bearing outer races for input and countershafts in the transmission or intermediate housing. The bearing surfaces must face in.

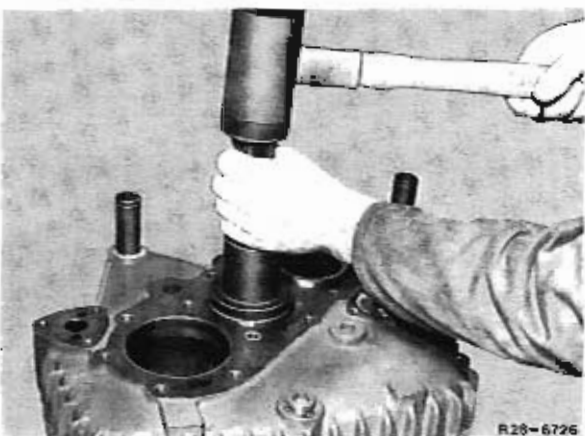

28.3 Assembly and Disassembly of Transfer Case

5 Press piston used for off-road gear out of the intermediate housing and remove.

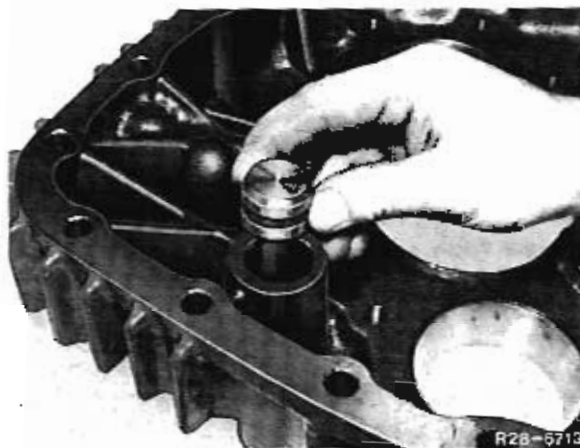

6 Draw selector shaft for on-road and off-road gear out of selector fork and housing.

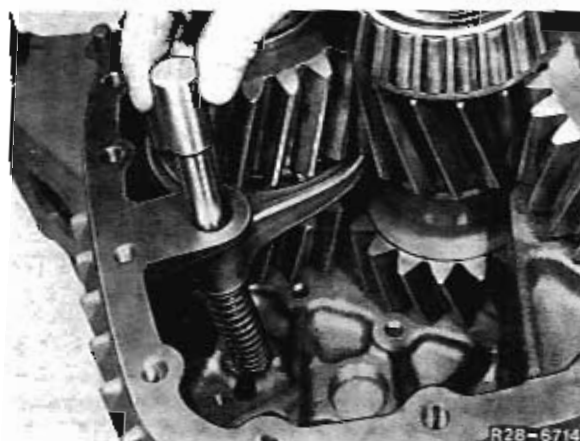

7 Remove spring and selector fork for on-road/off-road gear.



8 Lift input shaft out of the transmission housing, lifting countershaft slightly and pressing it to one side (for disassembly of input shaft see 28.3-119).

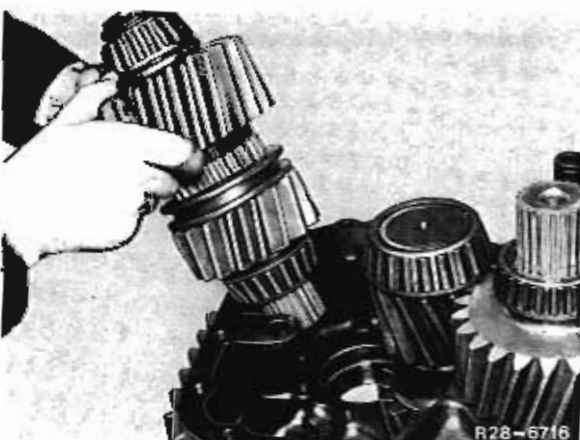

7 Coat cylinder surface and piston with paste to prevent rusting. (DB Part No. 000 989 80 51).

8 Insert piston in cylinder.

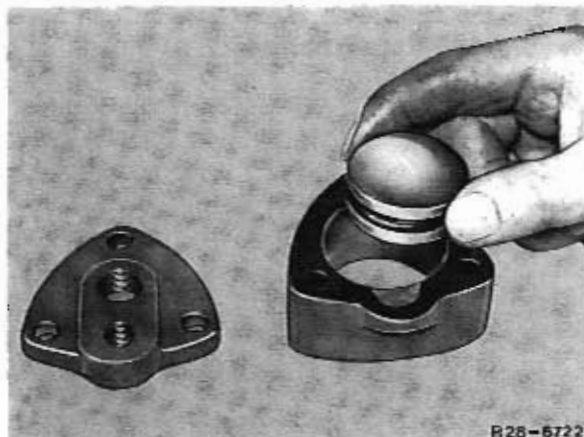

R28-6722

9 Place cylinder together with cover and new seals on transmission housing.

10 Screw in new micro-encapsulated clamping bolts and tighten to 25 Nm (2.5 kpm).

Note: The clamping bolts can be reused if the threads are cleaned and coated with a sealing compound such as Atmosit.

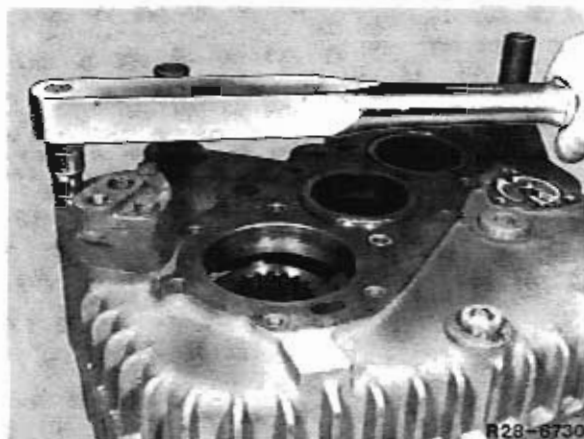

R28-6730

11 Insert input shaft to front axle in the housing and the sliding sleeve.

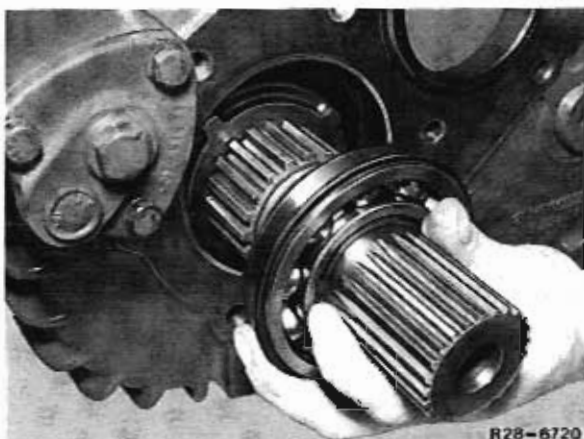

R28-6720

12 Press roller bearing onto input shaft journal.



R28-6719

28.3 Assembly and Disassembly of Transfer Case

13 Unscrew shift cylinder used for front wheel drive and for on-road and off-road operation from transmission housing.

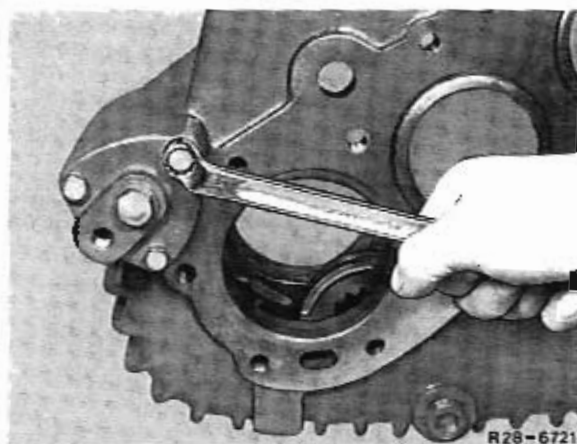

14 Remove cover and press piston out of cylinder.

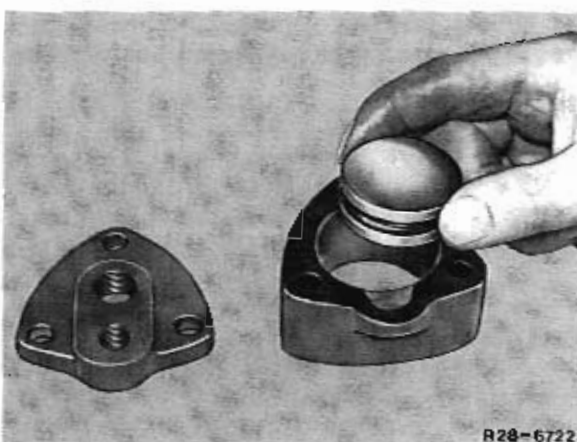

15 Draw selector shaft for front wheel drive out of transmission housing.



16 Remove selector fork, sliding sleeve and spring from housing.



18 Place sliding sleeve together with selector fork in on-road position. Insert spring beneath selector fork.

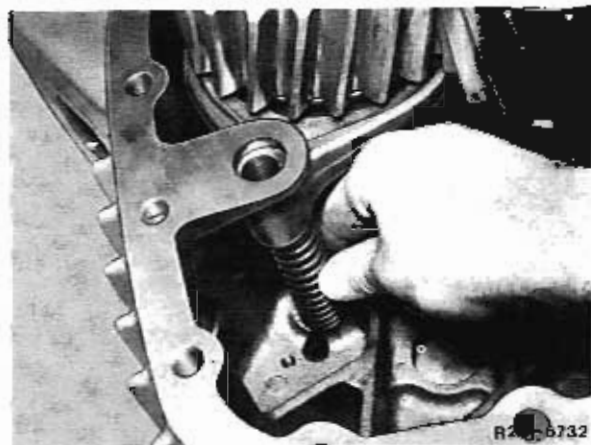

19 Align selector fork and spring. Insert selector shaft in selector fork and in the housing.

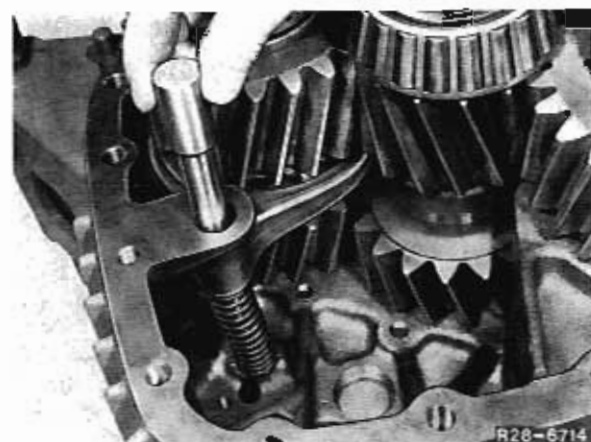

20 Place O-ring in piston for on-road and off-road gear.



21 Coat cylinder in intermediate housing and piston with paste to prevent rusting (DB No. 000 989 80 51). Insert piston in cylinder.

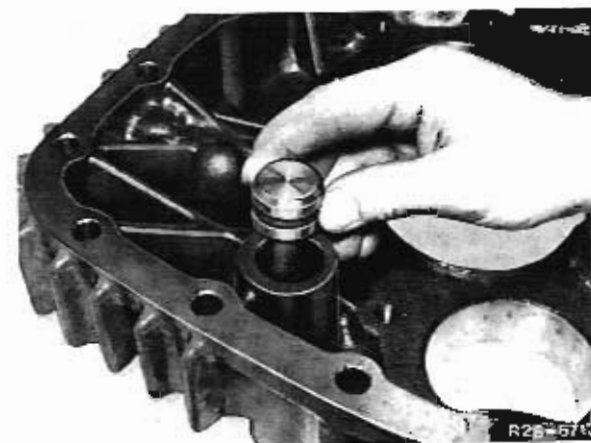

28.3 Assembly and Disassembly of Transfer Case

3 Insert selector fork and sliding sleeve for front wheel drive in the housing. Sliding sleeve must be inserted large collar first.

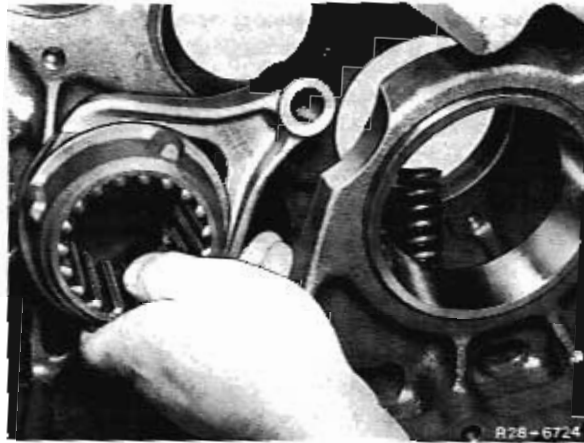

4 Insert spring (short), prestress with screwdriver and position correctly on seat provided in selector fork.

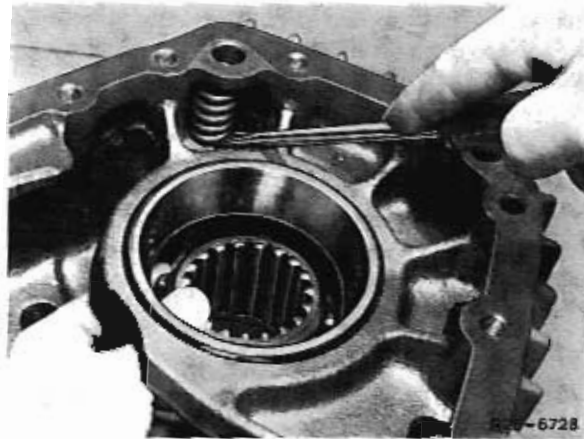

5 Align selector fork and spring. Insert selector shaft into housing and selector fork.

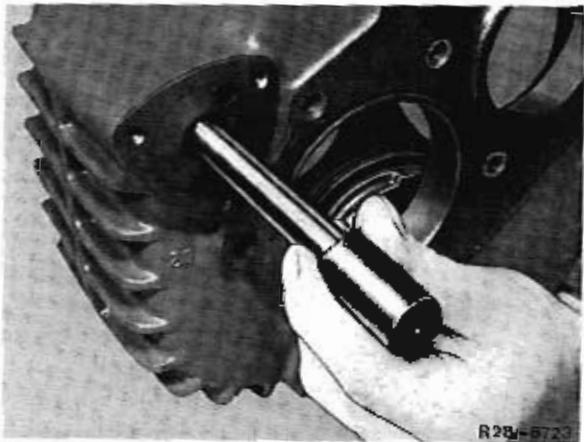

6 Fit O-ring in piston for front wheel drive.



28 Place new gasket on sealing surface of transmission housing.
Using special tool, mount outer race of taper roller bearing on transmission input shaft so that there is no play. (Do not jam bearing).

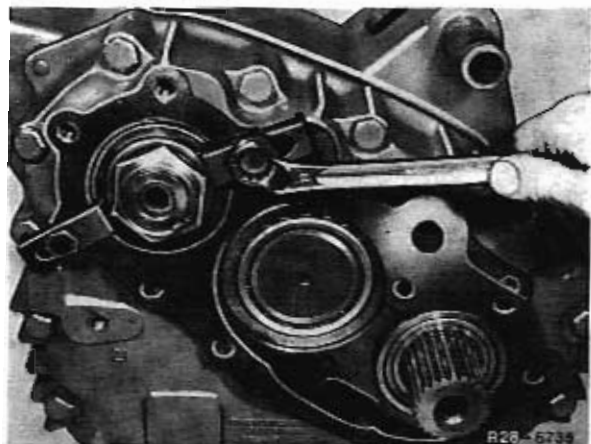

Clamping Bars 000 589 59 63 00

29 Place dial gauge and dial gauge holder on level, ground surface. Adjust so that needle points to 0.

30 Place gauge holder on sealing surface or gasket. Hold feeler pin against outer race of bearing and take measurement.

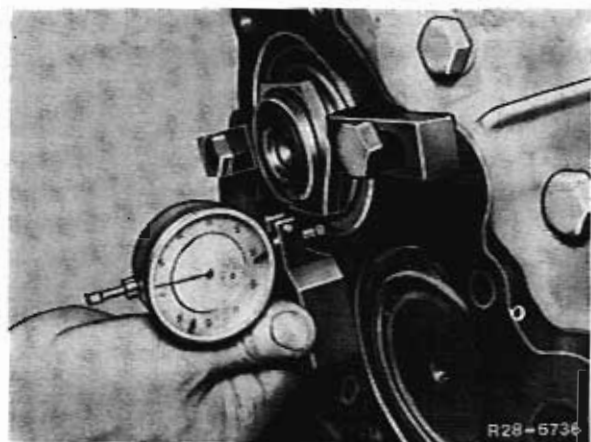

Dial Gauge 001 589 53 21 00
Dial Gauge Holder 343 589 00 40 00

31 Choose shims that will allow play of 0.08 ± 0.02 mm.

Shims of 0.05–0.1 and 0.3 mm thickness are available.

Note: A new gasket is compressed approx. 0.50 mm when the cover is mounted, and it is necessary to allow for this.

32 Using special tool, mount outer race of taper roller bearing on the countershaft so there is no play. (Do not jam bearing).

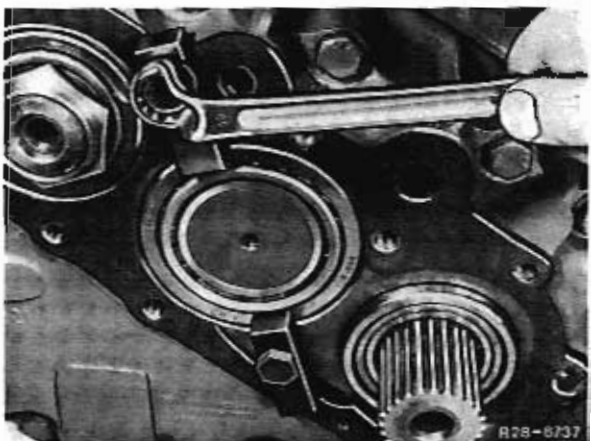

Clamping Bar 000 589 59 63 00

28.3 Assembly and Disassembly of Transfer Case

13 Position input shaft to rear axle in the transmission housing and in bearing.



14 Position countershaft in the transmission housing and in bearing.

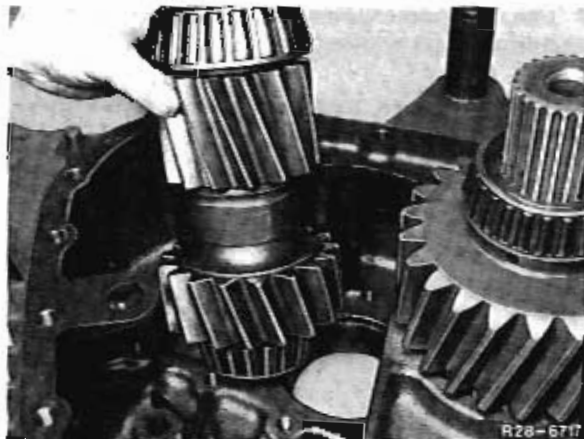

15 Place complete input shaft in housing.

16 Mount front end cover with new gasket (28.3-151).



17 Insert selector fork for on-road and off-road operation in the input shaft sliding sleeve.



37 Place gauge and gauge holder on the outer race of bearing with pin placed on the sealing surface or gasket. Adjust gauge needle to point at 0.

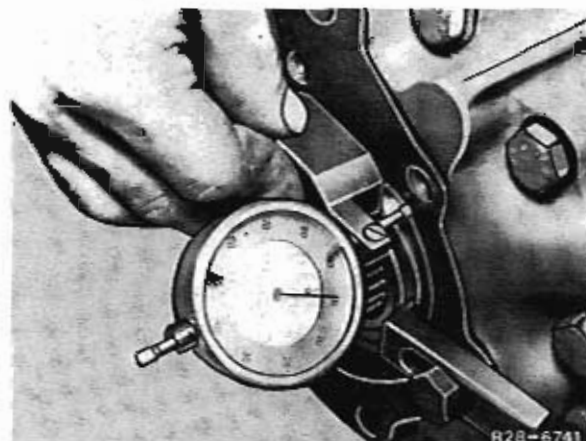

Dial Gauge 001 589 53 21 00
Dial Gauge Holder 343 589 00 40 00

38 Using gauge and gauge holder, measure distance from sealing surface to shim. This distance must exceed projection of outer race of taper roller bearing by 0.08 ± 0.02 mm.

Discrepancies are to be compensated for using shims. These are available in thicknesses of 0.05, 0.1, 0.2, 0.4 and 0.8 mm.

Note: A new gasket is compressed approx. 0.05 mm when the cover is mounted, and it is necessary to allow for this.

39 Mount rear end cover, using new gasket (28.3-153).

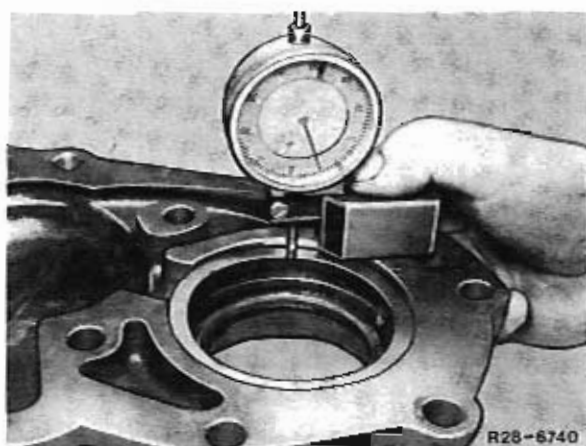

28.3 Assembly and Disassembly of Transfer Case

22 Place new gasket on sealing surface. Mount intermediate housing on dowel pin and position on sealing surface. Screw in clamping bolts and tighten to 90 Nm (9 kpm).

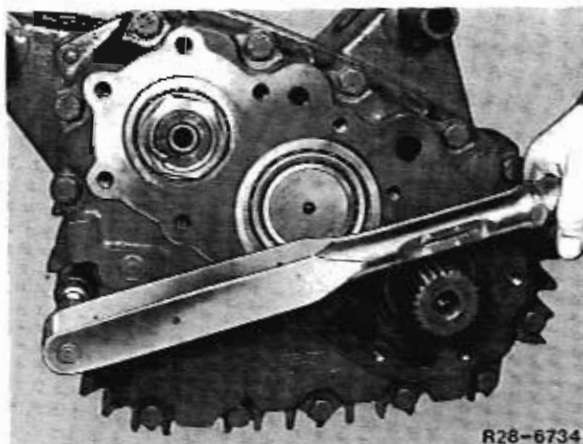

23 Place O-ring in piston for on-road/off-road gear.



24 Coat cylinder surface and piston with paste to prevent rusting. (DB Part No. 000 989 80 51).

25 Insert piston in cylinder.

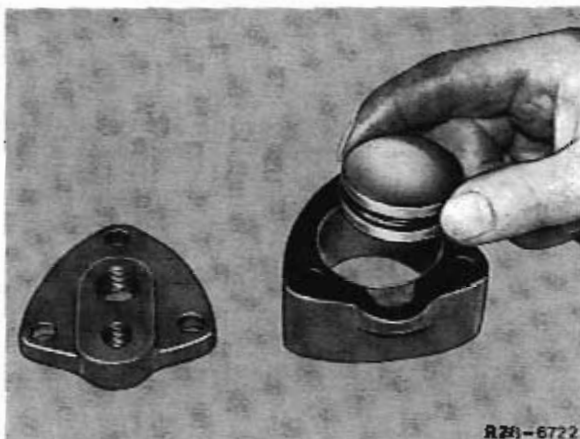

26 Place cylinder together with cover and new gaskets on transmission housing.

27 Screw in new micro-encapsulated clamping bolts and tighten to 25 Nm (2.5 kpm).

Note: Clamping bolts can be reused if the threads are cleaned and coated with a sealing compound such as Atmosit.

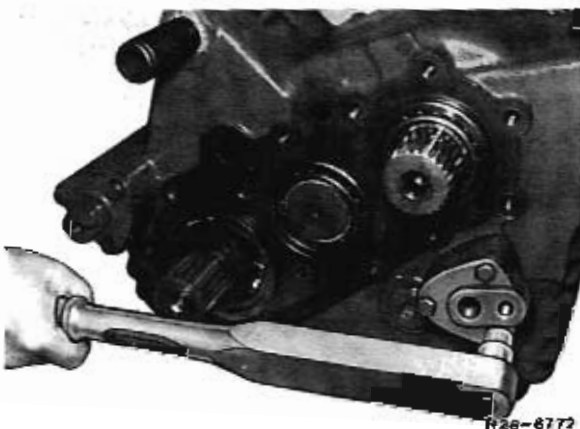

Tightening Torque Nm (kpm) 750.5

Collar nut on input shaft 350 (35)

Special Tools

Clamping ring 380 589 00 34 00

Clamping ring 380 589 01 34 00

Clamping ring 380 589 02 34 00



Puller



001 589 40 33 00

Puller



001 589 19 33 00

Thrust piece



387 589 01 63 00

Two-legged puller

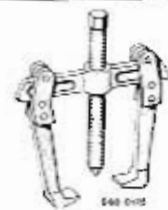

000 589 89 33 00

Input Shaft to Rear Axle

Removing Bearing

1 Pull large taper roller bearing from shaft using puller, clamping ring and thrust piece.

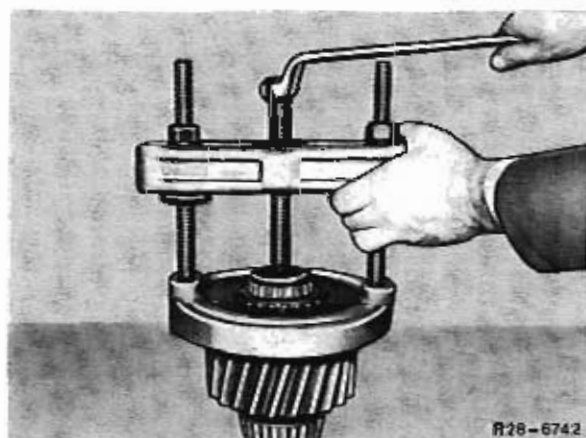

Puller 001 589 40 33 00
Clamping ring 380 589 00 34 00
Thrust piece 387 589 01 63 00

R28-6742

28.3 Assembly and Disassembly of Transfer Case

33 Place gauge together with gauge holder on level surface and adjust so that needle points to 0.

34 Hold feeler pin against bearing outer race of countershaft and record measurement.

Choose shims that allow play of 0.08 ± 0.02 mm.

Shims of 0.05–0.1, 0.15 and 0.3 mm thickness are available.

Dial Gauge 001 589 53 21 00
Dial Gauge Holder 343 589 00 40 00

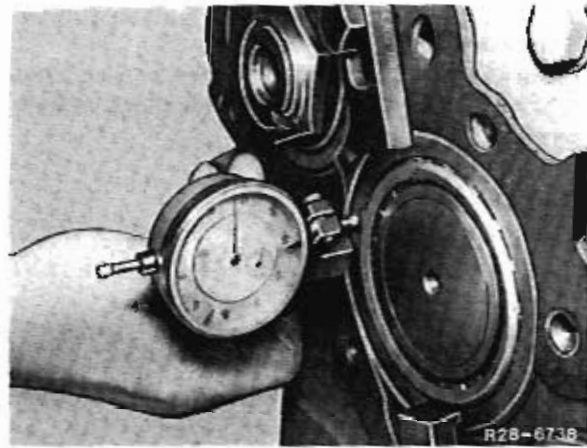

Note: A new seal is compressed approx. 0.05 mm when the cover is mounted, and it is necessary to allow for this.

35 Place spacing ring and shim in recess in the housing cover.

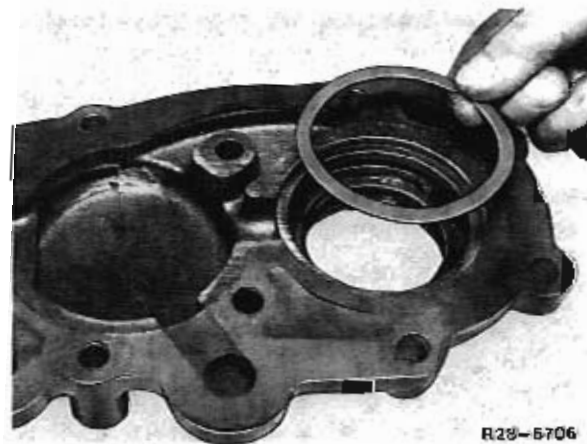

36 Using special tool, mount outer race of taper roller bearing on the input shaft to the rear axle so that there is no play. (Do not jam bearing).

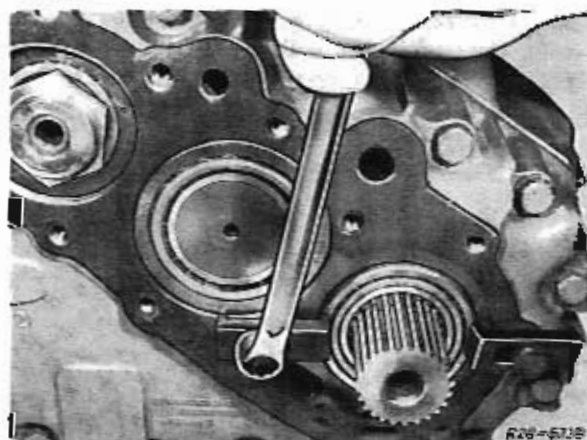

Clamping Bar 100639 59 83 00

- Heat speedometer pinion to approx. 120°C using heating plate and press onto shaft with large collar facing bearing.

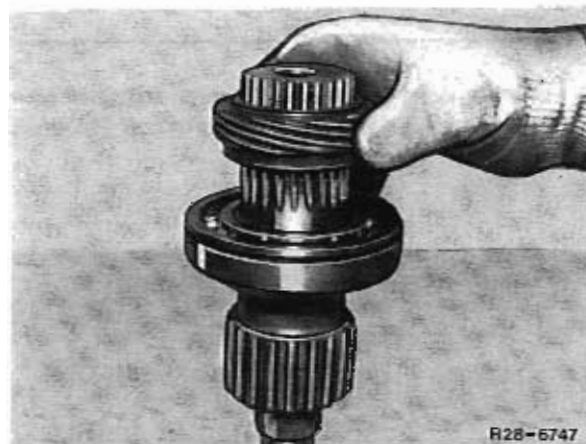

R28-6747

Countershaft

Removing Bearing

- Using puller and clamping ring, pull small taper roller bearing off countershaft.

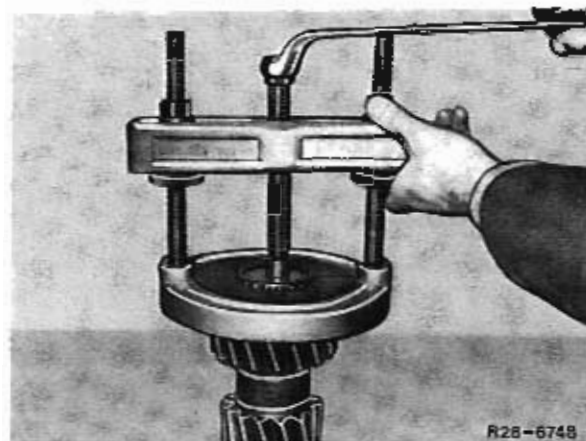

R28-6748

Puller 001 589 40 33 00
Clamping ring 380 589 01 34 00

- Using puller and clamping ring, pull large taper roller bearing off countershaft.

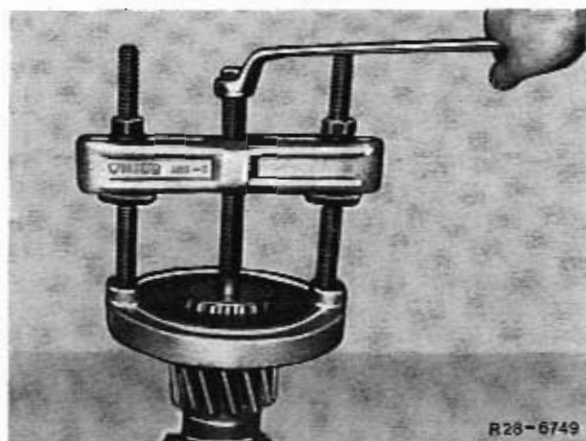

R28-6749

Puller 001 589 40 33 00
Clamping ring 380 589 02 34 00

Installing Bearing

- Heat small and large taper roller bearings to approx. 120 °C and press onto countershaft. Press on bearing inner race with appropriate tool as far as it will go.

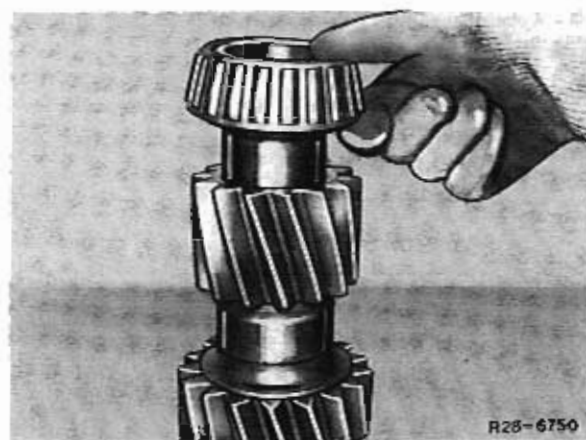

R28-6750



5 Using special tool, remove gear together with thrust washer and taper roller bearing from the input shaft.

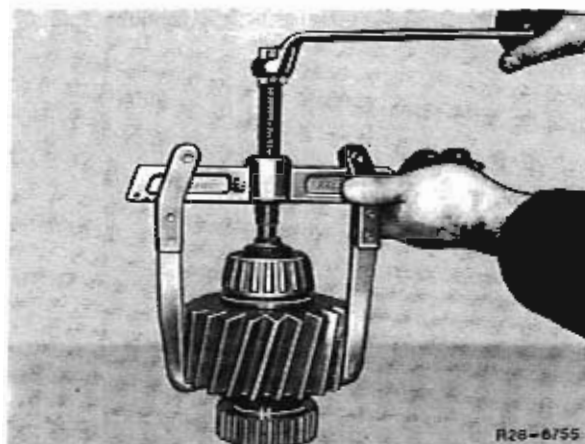

Puller 000 588 89 33 00

6 Remove straight pin from input shaft.

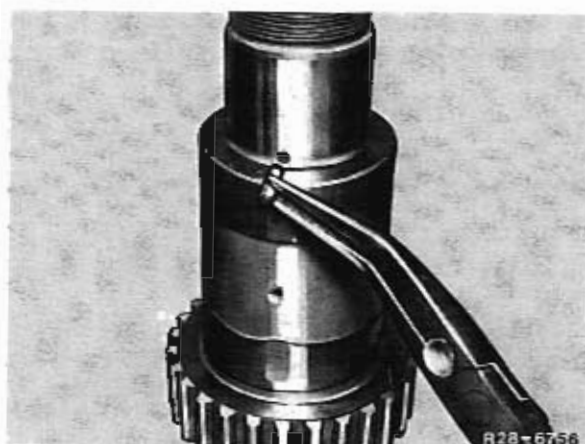

Assembling Input Shaft

1 Insert straight pin in the input shaft.

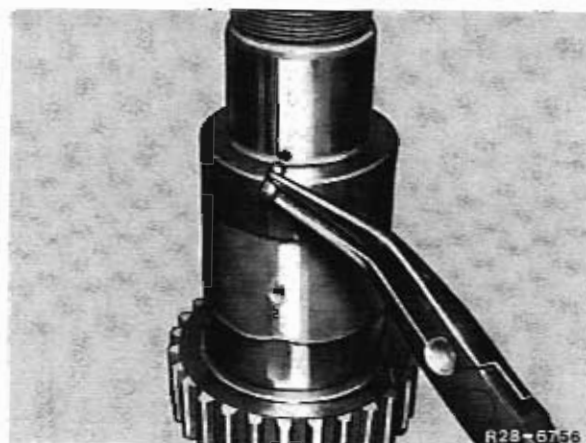

2 Moisten bearing points on shaft with gear oil. Press gear onto shaft with the spines facing the middle of the shaft.

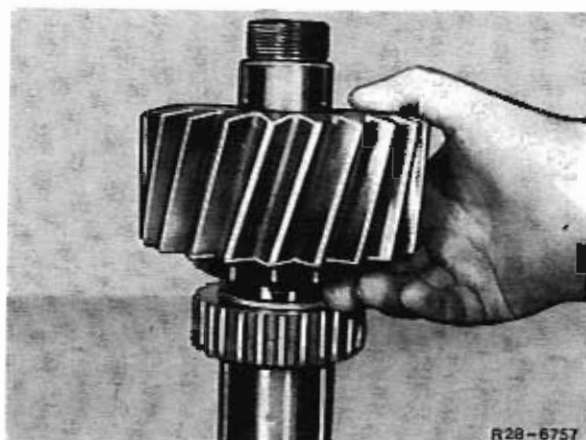

28.3 Assembly and Disassembly of Countershaft and Input Shafts

2 Pull small taper roller bearing off input shaft using special tool.

Puller 001 589 19 33 00

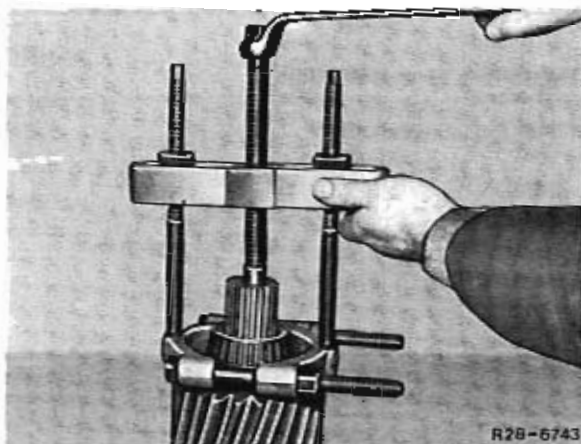

Installing Bearing

1 Heat taper roller bearing to approx. 120 °C with a heating plate and press onto input shaft. Press against bearing inner race with appropriate tool as far as it will go.

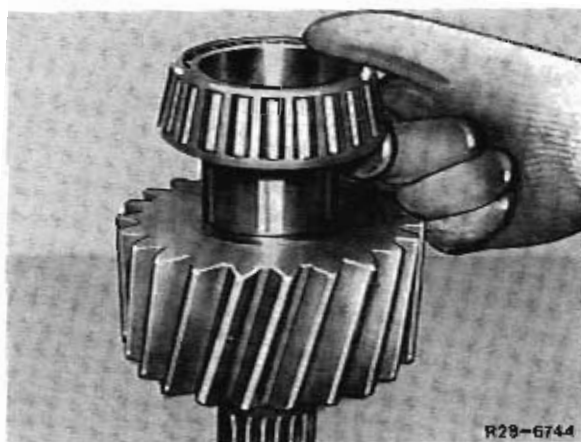

Input Shaft to Front Axle

Disassembly

1 Using special tool, draw deep groove ball bearing and speedometer pinion off the shaft.

Puller 000 589 89 33 00

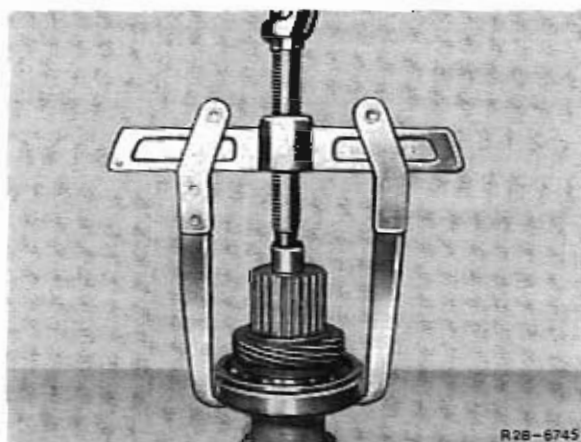

Assembly

1 Heat deep groove ball bearing to approx. 120 °C and press onto shaft as far as collar.

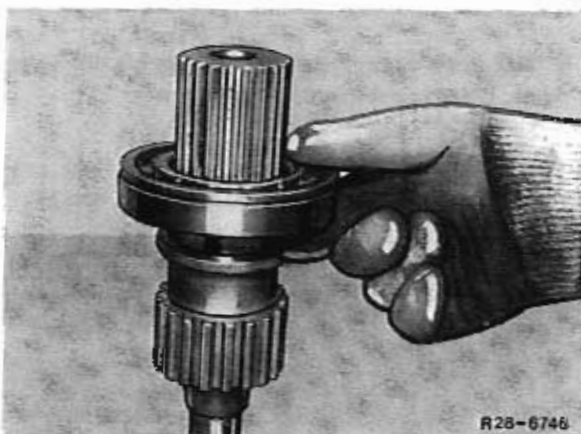

7 Press roller cage assembly onto bearing seat.

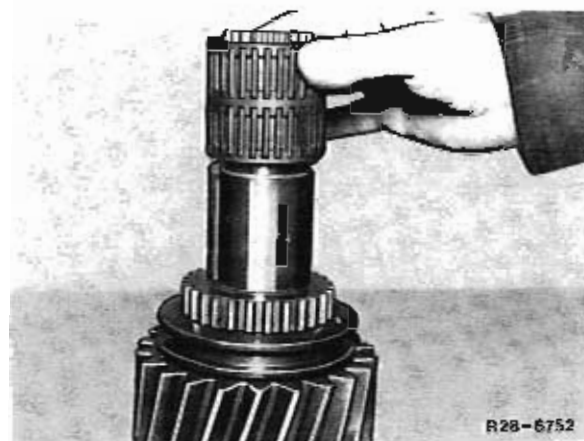

8 Press gear splines foremost over the roller cage assembly.

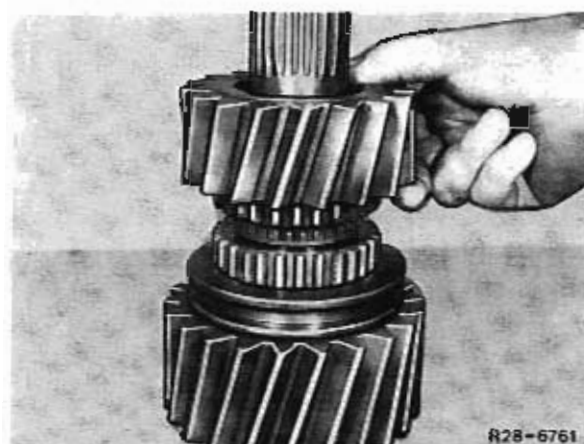

9 Slip thrust washer over shaft and position against gear.



10 Heat taper roller bearing to approx. 120 °C and press onto bearing seat. Using an appropriate tool, press on the inner race of bearing until it is correctly positioned against thrust washer.



28.3 Assembly and Disassembly of Countershaft and Input Shafts

Disassembling Input Shaft

1 Using special tool, pull small gear together with thrust washer and taper roller bearing off the input shaft.

Two-legged puller 000 589 69 03 00

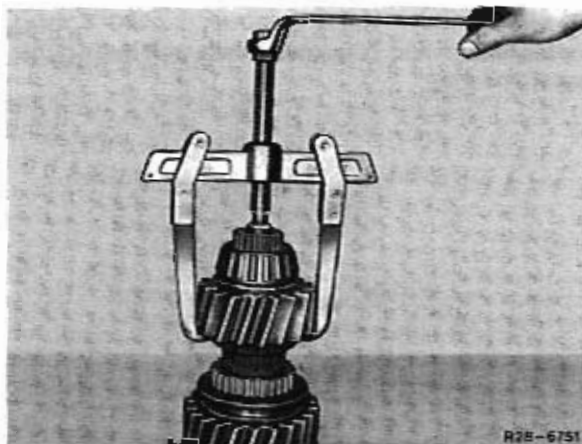

2 Remove roller cage assembly from shaft.



3 Remove sliding sleeve.

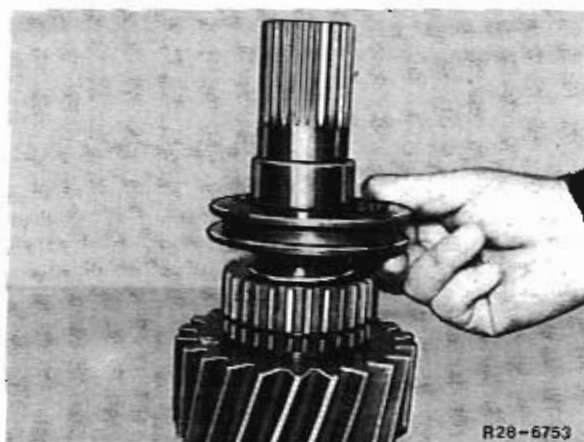



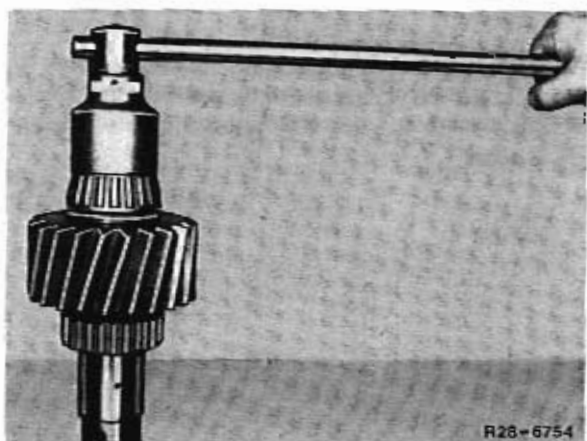

4 Release collar nut, loosen with socket wrench SW 55 and remove.

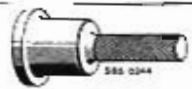

Tightening Torques Nm (lpm)

Clamping Bolts - Coupling Flange	250 (25)
Clamping Bolts - Housing Cover	90 (9)

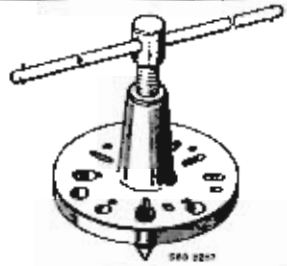
Special Tools

Drift		387 589 05 15 00
Dial Gauge		001 589 53 21 00
Retaining Wrench		366 589 00 31 00
Puller		035 589 01 33 00
Gauge Holder		343 589 00 40 00

Technical Data

Axial play Input Shaft/Front Axle (Axial play deep groove ball bearing outer race to housing cover)	0-0.1 mm
Distance from housing cover to outer sealing ring	8 mm

Removal

1 Release centre bolt on flange to transmission and to front axle and remove it. Hold flange with special tool.

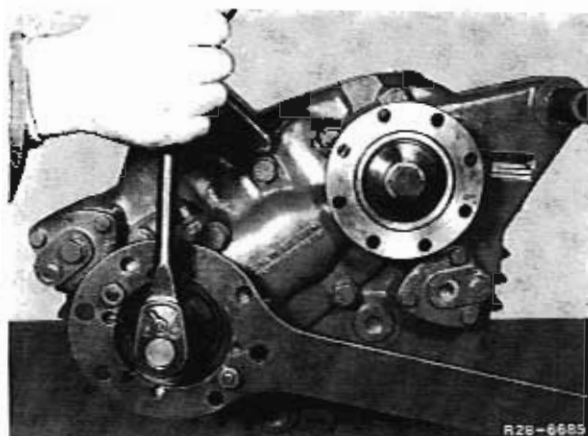

Retaining Wrench 366 589 00 31 00

R2e-6685

28.3 Assembly and Disassembly of Countershaft and Input Shafts

3 Slip thrust washer over shaft and position against gear wheel.

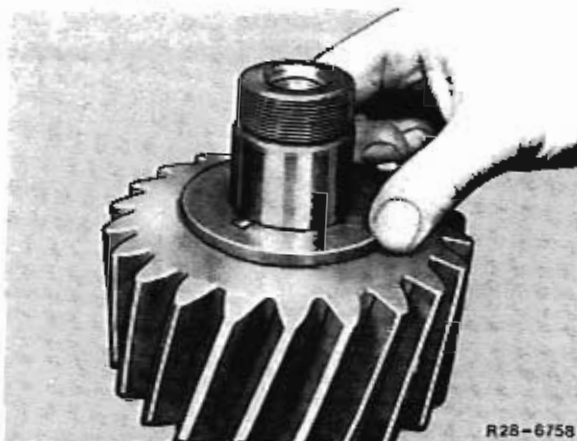

4 Heat taper roller bearing to approx. 120 °C and press onto shaft bearing seat.



5 Screw on new collar nut and tighten to 350 Nm (35 kpm). Secure nut.

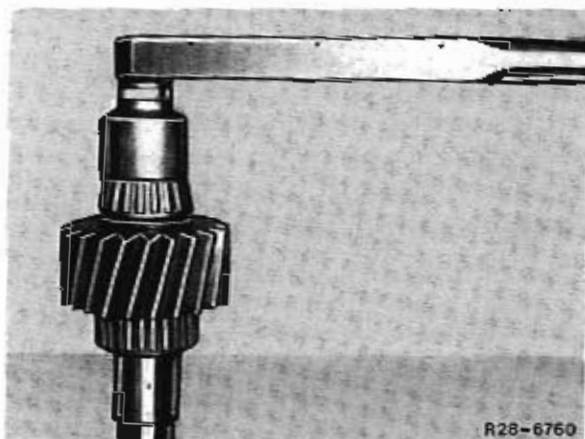

6 Mount sliding sleeve.

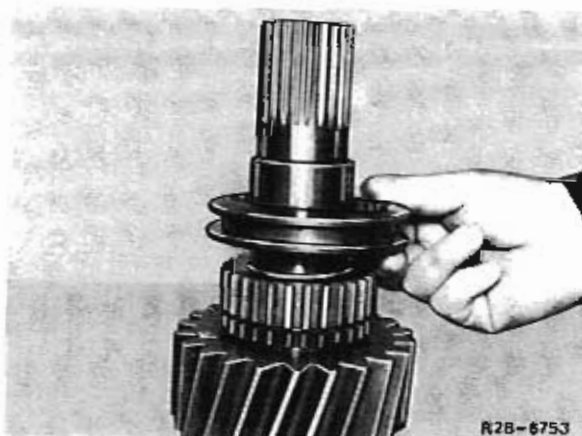

- 6 Press radial sealing ring out of the housing cover.
- 7 Clean housing cover of any remains of the sealing ring.

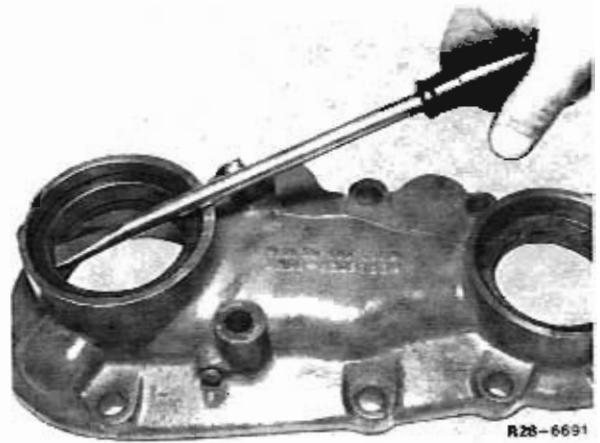

R28-6691

Installation

- 1 Coat edge of sealing ring with sealing compound.
- 2 Using special tool, first drive in the inner sealing ring approx. 18 mm with sealing lip leading. Then drive the outer sealing ring into the housing cover until it is lying against the inner ring. Do not confuse inner and outer rings. (Watch for part numbers).

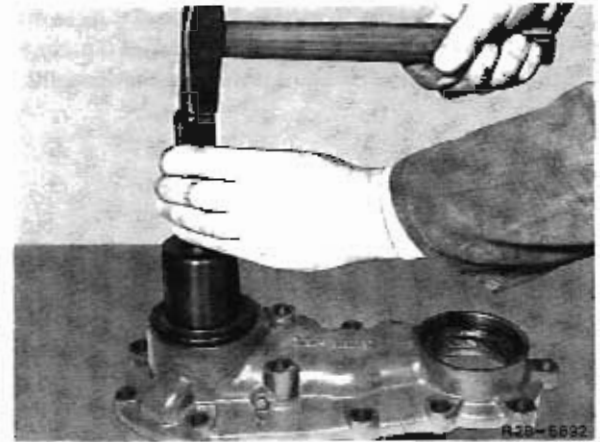

R28-6692

Drift 387 569 05 15 00

- 3 Check that distance "A" (from front edge of the housing to outer radial sealing ring) is equal to 8 mm.

Pack space between the sealing rings with long-life grease.

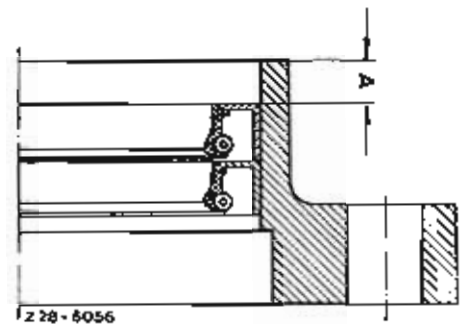

2 28 - 6056

- 4 Place spacing ring in the recess in the housing cover at the taper roller bearing.

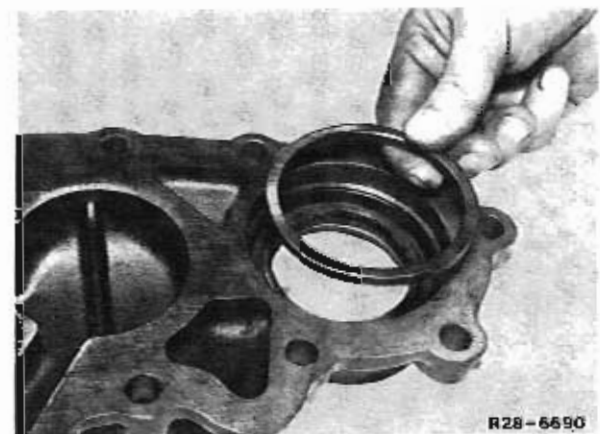

R28-6690



8 Place cover together with new gasket on housing.

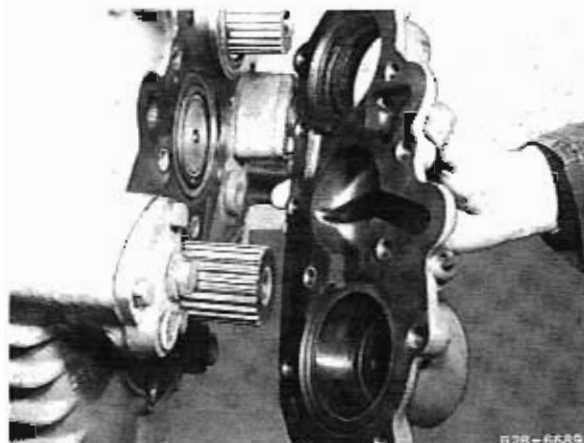

9 Screw in new clamping bolts with micro-encapsulated adhesive along perimeter of cover and tighten to 90 Nm (9 kpm).

Note: The clamping bolts can be reused if the threads are cleaned and coated with a sealing compound such as Almost.

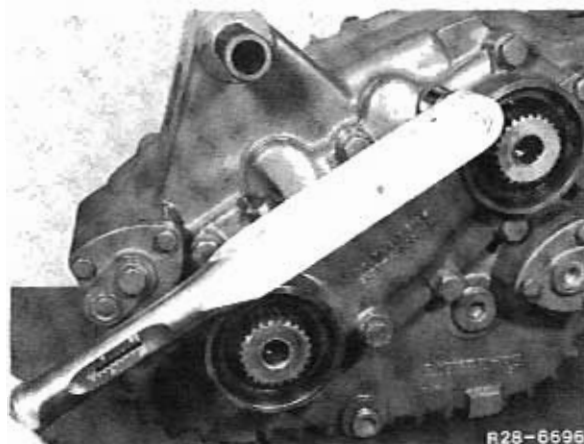

10 Heat coupling flanges to approx. 120 °C and press onto input and output shafts.

Note: Do not confuse coupling flanges. Mount flange with groove at guides on shaft to transmission.

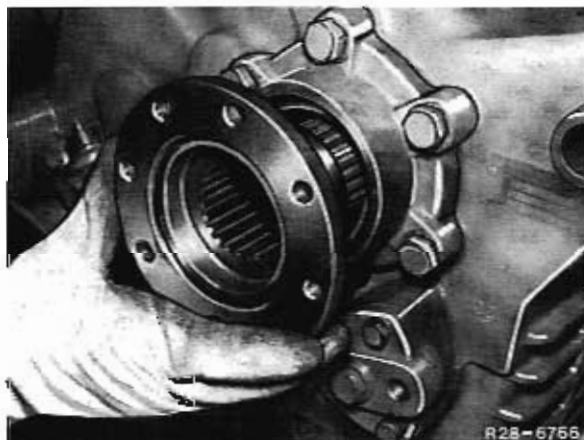

11 Attaching special tool to input or output flange, screw in centre clamping bolt using thrust piece and tighten to 250 Nm (25 kpm).

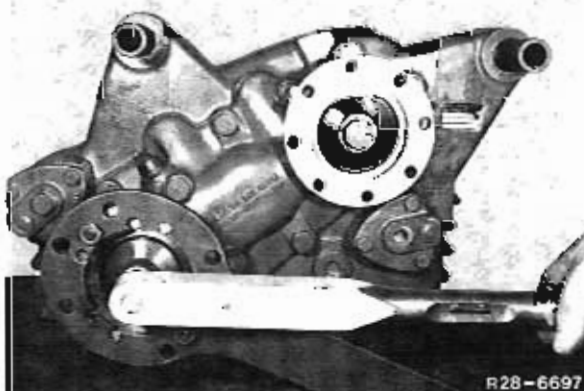

Retaining sleeve: 926 669 00 in 10

28.3 Removal, Installation and Sealing of Housing Cover

5 Place shims in the recess of the housing cover at the deep groove ball bearing.



6 Place new gasket on sealing surface of the cover. Insert gauge in gauge holder and measure distance from shim to gasket. **Make a note of measurement!**

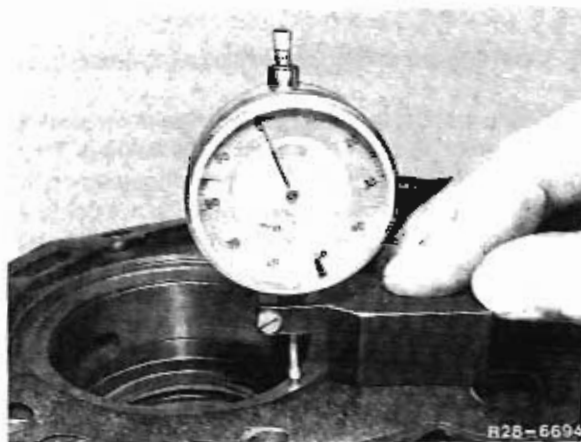

Dial Gauge 001 589 53 21 00
Dial Gauge Holder 343 589 00 40 00

7 Using gauge and gauge holder, measure from deep groove ball bearing to parting surface. Ensure that there is no play between the race of the deep groove ball bearing and the parting surface.

This measurement must be equal to or up to 0.1 mm less than that taken at 6 above.

Any discrepancies are to be compensated for with shims. These are available in thicknesses of 0.05, 0.1 and 0.3 mm.

Note: A new gasket is compressed approx. 0.05 mm when the cover is mounted, and it is necessary to allow for this.



750.5

Tightening Torques Nm (kpm)

Clamping Bolts – Coupling Flange 250 (25)

Clamping Bolts – Housing Cover 90 (9)

Special Tools

Drift  387 589 05 15 00

Retaining Wrench  366 589 00 31 00

Puller  035 589 01 33 00

Technical Data

Distance from housing cover to outer sealing ring 8 mm

Removal

1 While holding flange with special tool, release and remove centre clamping bolt at flange to rear axle.

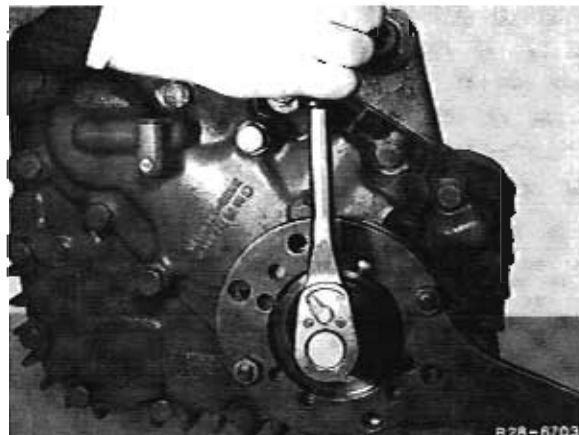

Retaining wrench 366 589 00 31 00

2 Attach special tool at flange to rear axle. Using special tool, pull coupling flange off input shaft to rear axle.

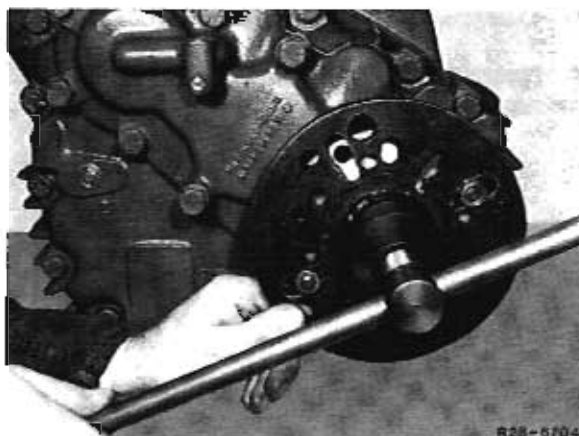

Puller 035 589 01 33 00

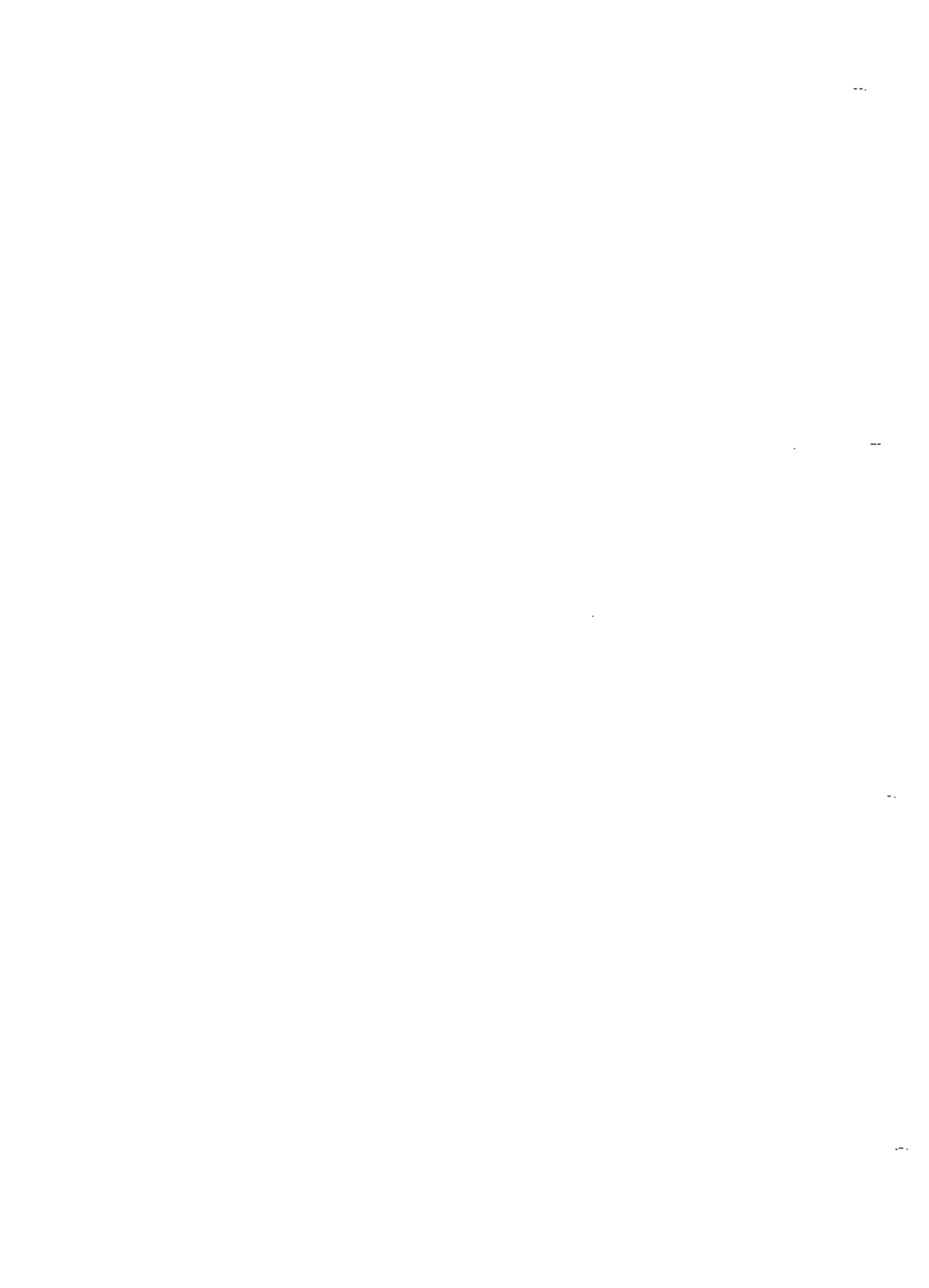

Installation

- 1 Coat edge of radial sealing ring with sealing compound.
- 2 Using special tool, drive the inner sealing ring approx. 18 mm into the housing cover with sealing lip leading. Then drive in the outer ring until it is lying on the inner one.

D-11 387 589 05 15 03



- 3 Check that distance "A" (from front edge of housing to outer radial sealing ring) is equal to 8 mm.

Pack space between sealing rings with long-life grease.

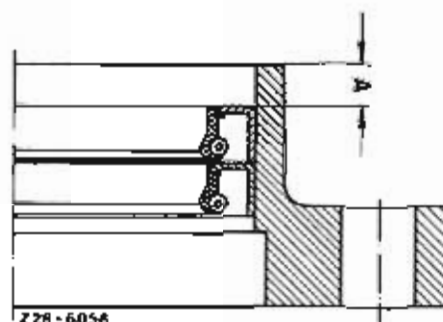

- 4 Place spacing ring in recess at output.
- 5 Fix shims for the input and countershafts to the taper roller bearing outer races with grease. Place shims for output in the recess prior to installing spacing ring. (To measure axial play of shaft or to determine thickness of shims see 28.3-117).

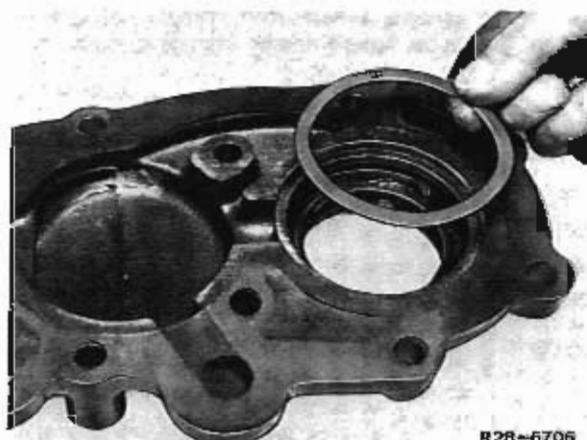

- 6 Place cover together with new gasket on housing.

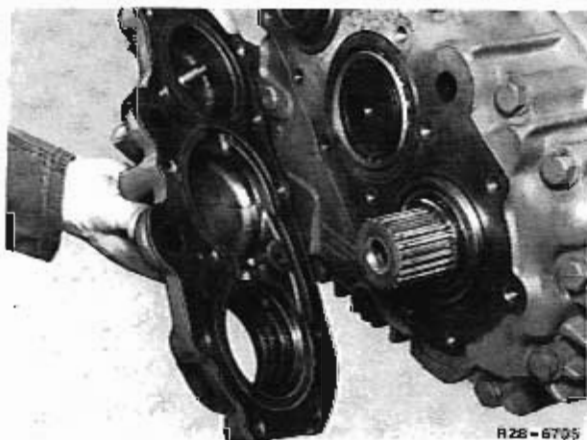

28.3 Removal and Installation of Rear End Cover

7 Insert new micro-encapsulated bolts along perimeter of housing cover and tighten to 90 Nm (9 kpm).

Note: Micro-encapsulated sealing bolts can be reused if the threads are cleaned and a sealing compound such as Atmosit is applied.

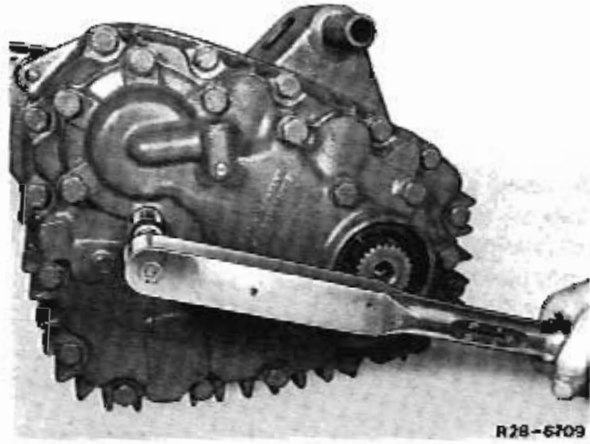

8 Slip inner spacing ring over the output shaft and position on the bearing inner race.

9 Heat input flange to rear axle to approx. 120 °C and press onto the input shaft.

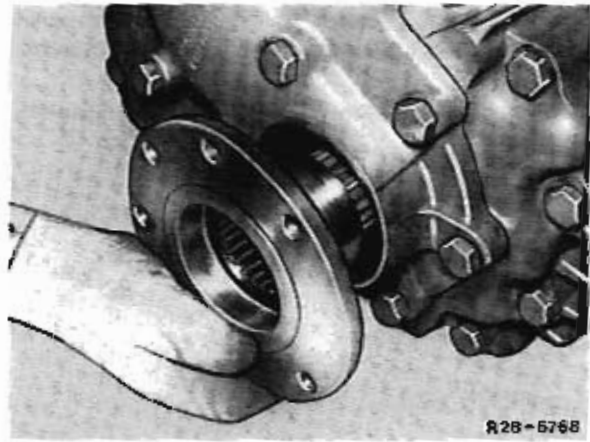

10 While holding flange with special tool, place thrust piece on flange, insert clamping bolts and tighten to 250 Nm (25 kpm).

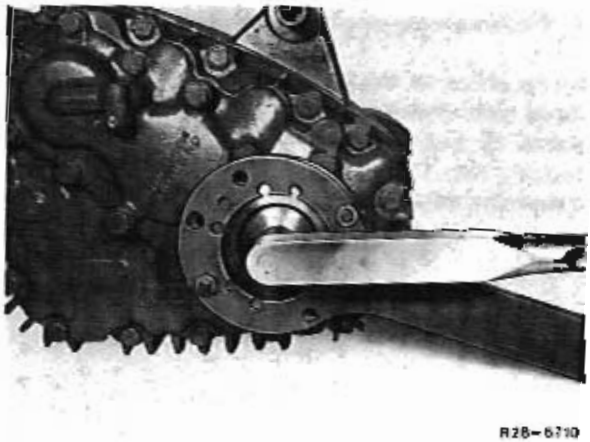

Tightening Torque Nm (kpm)

Speedometer connecting piece	55 (5.5)
------------------------------	----------

Technical Data

Projection of speedometer pinion shaft	ca. 10 mm
----------------------------------------	-----------

Disassembly

- 1 Remove front end cover (28.3-151)
- 2 If speedometer connecting piece is damaged or no longer leak-tight, unscrew and remove from housing cover.

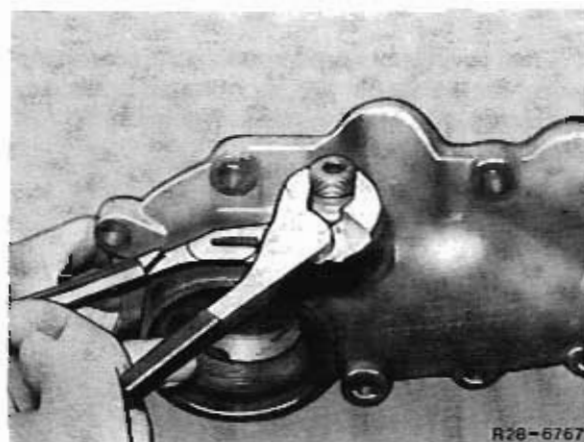

- 3 Pull plug opposite connecting piece out of housing cover.



- 4 Using a suitable drift, drive the speedometer drive shaft out of the housing cover. Remove the speedometer drive gear that has been released from the housing.

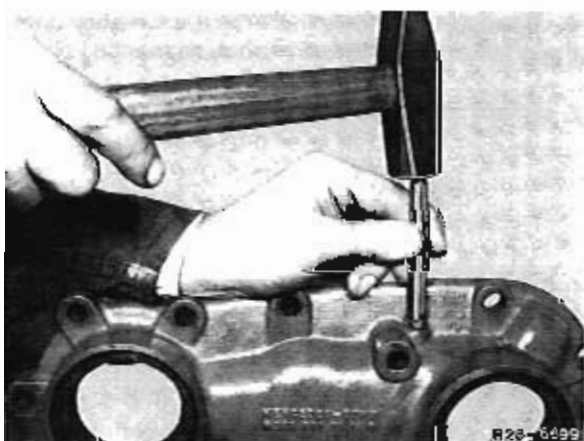

28.3 Assembly and Disassembly of Speedometer Drive

- 5 Pull speedometer worm down off input shaft.
- 6 Check all parts for wear.

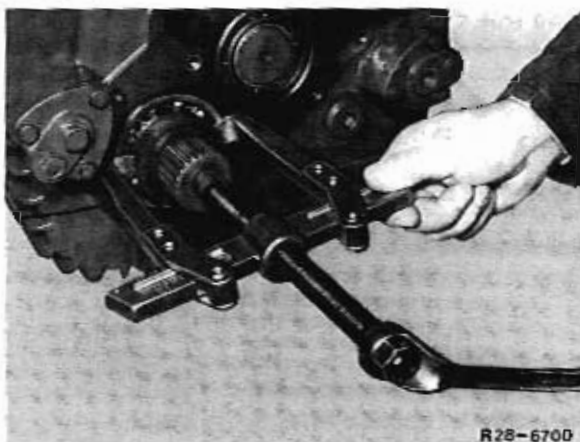

Installation

- 1 Coat threads of speedometer shaft connecting piece with Loctite Nr. 270 (as indicated by arrows) and screw into housing cover. Tighten to 55 Nm (5.5 kpm).

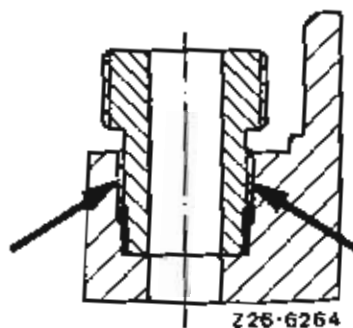

- 2 Lubricate speedometer drive shaft and gear with gear oil.
- 3 Place speedometer drive gear in housing cover and insert drive shaft.



- 4 Press speedometer shaft into the drive gear until the driver projects 10 mm beyond connecting piece.
- 5 Check that drive runs easily.

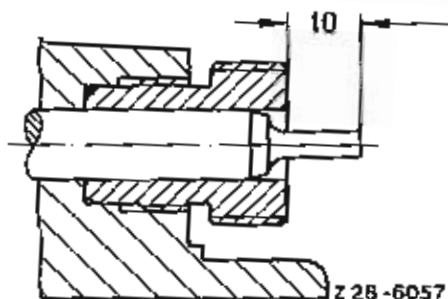

Assembly and Disassembly of Speedometer Drive 28.3

6 Heat speedometer worm to approx. 80 °C and press onto output shaft. The large collar of the speedometer worm must face bearing.

7 Coat plug with Loctite 270 and place in hole in cover.

8 Install housing cover (28.3-151).



